



745i

745Li

760Li

Congratulations, and thank you for choosing a BMW.

Thorough familiarity with your vehicle will provide you with enhanced control and security when you drive it. We therefore have this request:

Please take the time to read this Owner's Manual and familiarize yourself with the information that we have compiled for you before starting off in your new vehicle. It contains important data and instructions intended to assist you in gaining maximum use and satisfaction from your BMW's unique range of technical features.

The manual also contains information on maintenance designed to enhance operating safety and contribute to maintaining the value of your BMW throughout an extended service life.

This Owner's Manual should be considered a permanent part of this vehicle. It should stay with the vehicle when sold to provide the next owner with important operating, safety and maintenance information.

This manual is supplemented by a Service and Warranty Information Booklet for US models or a Warranty and Service Guide Booklet for Canadian models.

We wish you an enjoyable driving experience.

BMW AG

© 2003 Bayerische Motoren Werke
Aktiengesellschaft
Munich, Germany
Reprinting, including excerpts, only with the
written consent of BMW AG, Munich.
Order Number 01 41 0 157 670
US English VIII/2003, 6 126
Printed in Germany
Printed on environmentally friendly paper,
bleached without chlorine, suitable for recycling.

Contents

The fastest way to find specific topics is to use the index, refer to page 216.

Using this Owner's Manual

- 4 Notes
- 7 Reporting safety defects

At a glance

- 10 Cockpit
- 17 Control Center
- 25 Voice command

Controls

- 32 Opening and closing
- 44 Adjustments
- 56 Transporting children safely
- 60 Driving
- 80 Everything under control
- 90 Technology for comfort, convenience and safety
- 99 Lamps
- 102 A congenial climate
- 111 Practical interior accessories

Driving tips

- 122 Things to remember when driving

Navigation

- 130 Starting the navigation system
- 132 Destination entry
- 139 Destination guidance
- 144 What to do if ...

Entertainment

- 148 On/off, tone
- 152 Radio
- 158 CD Compact Disc
- 160 CD changer
- 163 TV
- 165 DVD changer

Communications

- 174 Using the phone in your vehicle
- 182 BMW Assist

Mobility

- 186 Refueling
- 188 Wheels and tires
- 194 Under the hood
- 198 Maintenance
- 199 Rules and regulations
- 200 Replacing components
- 207 Giving and receiving assistance

Reference

- 212 Technical data
- 216 Everything from A to Z

Notes

Using this Owner's Manual

In compiling this Owner's Manual we have made every effort to furnish you with a convenient reference source affording quick access to all the essentials. The fastest way to find detailed information on any specific subject is to turn to the comprehensive index at the back of the manual. For a brief initial overview, please refer to the first chapter.

Should the day come when you decide to sell your BMW, please remember to make certain that the new owner receives this Owner's Manual; it is an important part of the vehicle.

Additional sources of information

If you have any additional questions, your BMW center will be glad to advise you.

You can find information on BMW, e.g. technology, on the Internet at www.bmwusa.com.

Symbols used



Indicates precautions that must be followed precisely in order to avoid the possibility of personal injury and serious damage to the vehicle.

◀ Marks the end of a specific item of information.



Contains information that will assist you in gaining the optimum benefit from your vehicle and enable you to care more effectively for your vehicle.



Refers to measures that can be taken to help protect the environment.

* Indicates special equipment, country-specific equipment and optional extras when available.

"..." Identifies Control Display texts used to select individual functions.



These sections contain information on using the voice command system.

›...‹ Verbal instructions to use with the voice command system.

›...‹‹ Identifies the answers generated by the voice command system.



Vehicle Memory, Key Memory, refer to page 54. Identifies functions that can be specifically adapted for a particular key or vehicle. These adjustments can be performed either by yourself or by your BMW center.

Symbols on vehicle components



Indicates that you should consult the relevant section of this Owner's Manual for information on a particular part or assembly.

The individual vehicle

On purchasing your BMW, you have decided in favor of a model with individualized equipment and features. This Owner's Manual describes the entire array of options and equipment available with a specific BMW model.

Please bear in mind that the manual may contain information on accessories and equipment that you have not specified for your own vehicle. Sections describing options and special equipment are marked by asterisks * to assist you in identifying possible differences between the descriptions in this manual and your own vehicle's equipment.

Should your BMW be equipped with features or accessories not described in this Owner's Manual, please consult the enclosed supplementary Owner's Manual(s).

Editorial notice

BMW pursues a policy of continuous, ongoing development that is conceived to ensure that our vehicles continue to embody the highest quality and safety standards combined with advanced, state-of-the-art technology.

For this reason, the features described in this Owner's Manual may differ from those on your vehicle. Nor can errors and omissions be entirely ruled out. You are therefore asked to appreciate that no claims can be entertained on the basis of the data, illustrations or descriptions in this Owner's Manual.

For your own safety

Fuels

 Use unleaded gasoline only. Fuels containing up to and including 10% ethanol or other oxygenates with up to 2.8% oxygen by weight – that is, 15% MTBE or 3% methanol plus an equivalent amount of co-solvent – will not void the applicable warranties with respect to defects in materials or workmanship. Field experience has indicated significant differences in fuel quality – volatility, composition, additives, etc. – among gasolines offered for sale in the United States and Canada. The use of poor-quality fuels may result in driveability, starting and stalling problems, especially under certain environmental conditions such as high ambient temperature and high altitude.

Should you encounter driveability problems which you suspect could be related to the fuel you are using, we recommend that you respond by switching to a recognized high-quality brand.

Failure to comply with these recommendations may result in unscheduled maintenance.

Follow the relevant safety rules when you are handling gasoline. ◀

Maintenance and repair

 Advanced technology, e.g. the use of modern materials and high-performance electronics, requires specially adapted maintenance and repair methods. Therefore, only have corresponding work on your BMW carried out by a BMW center or a workshop that works according to BMW repair procedures with correspondingly trained personnel. If work is carried out improperly there is a danger of consequential damage and the related safety risks. ◀

Parts and accessories

 For your own safety, use genuine parts and accessories approved by BMW.

When you purchase accessories tested and approved by BMW and Genuine BMW Parts, you simultaneously acquire the assurance that they have been thoroughly tested by BMW to ensure optimized performance when installed on your vehicle.

BMW warrants these parts to be free from defects in material and workmanship. BMW will not accept any liability for damage resulting from installation of parts and accessories not approved by BMW.

BMW cannot test every product made by other manufacturers to verify if it can be used on a BMW safely and without risk to either the vehicle, its operation, or its occupants.

Genuine BMW Parts, BMW Accessories and other products approved by BMW, together with professional advice on using these items, are available from all BMW centers.

Installation and operation of non-BMW approved accessories such as alarms, radios, amplifiers, radar detectors, wheels, suspension components, brake dust shields, telephones – including operation of any portable phone from within the vehicle without using an externally mounted antenna – or transceiver equipment, for instance, CBs, walkie-talkie, ham radio or similar accessories, may cause extensive damage to the vehicle, compromise its safety, interfere with the vehicle's electrical system or affect the validity of the BMW Limited Warranty. See your BMW center for additional information. ◀

 Maintenance, replacement, or repair of the emission control devices and systems may be performed by any automotive repair establishment or individual using any certified automotive part. ◀

Service and warranty

We recommend that you read this publication thoroughly.

Your BMW is covered by the following warranties:

- New Vehicle Limited Warranty
- Rust Perforation Limited Warranty
- Federal Emissions System Defect Warranty
- Federal Emissions Performance Warranty
- California Emission Control System Limited Warranty

Detailed information about these warranties is listed in the Service and Warranty Information Booklet for US models or in the Warranty and Service Guide Booklet for Canadian models.

Reporting safety defects

The following only applies to vehicles owned and operated in the US.

If you believe that your vehicle has a defect which could cause a crash or could cause injury or death, you should immediately inform the National Highway Traffic Safety Administration (NHTSA) in addition to notifying BMW of North America, LLC, P.O. Box 1227, Westwood, New Jersey 07675-1227, Telephone (800) 831-1117.

If NHTSA receives similar complaints, it may open an investigation, and if it finds that a safety defect exists in a group of vehicles, it may order a recall and remedy campaign. However, NHTSA cannot become involved in individual problems between you, your dealer, or BMW of North America, LLC.

To contact NHTSA, you may either call the Auto Safety Hotline toll-free at 1-800-424-9393 (or 366-0123 in Washington, D.C. area) or write to: NHTSA, U.S. Department of Transportation, Washington, D.C. 20590. You can also obtain other information about motor vehicle safety from the Hotline.









At a glance

This overview of buttons, switches and displays is intended to serve as a source of orientation in your vehicle's operating environment. The section will also assist you in becoming acquainted with the control concepts and options available for operating the various systems.

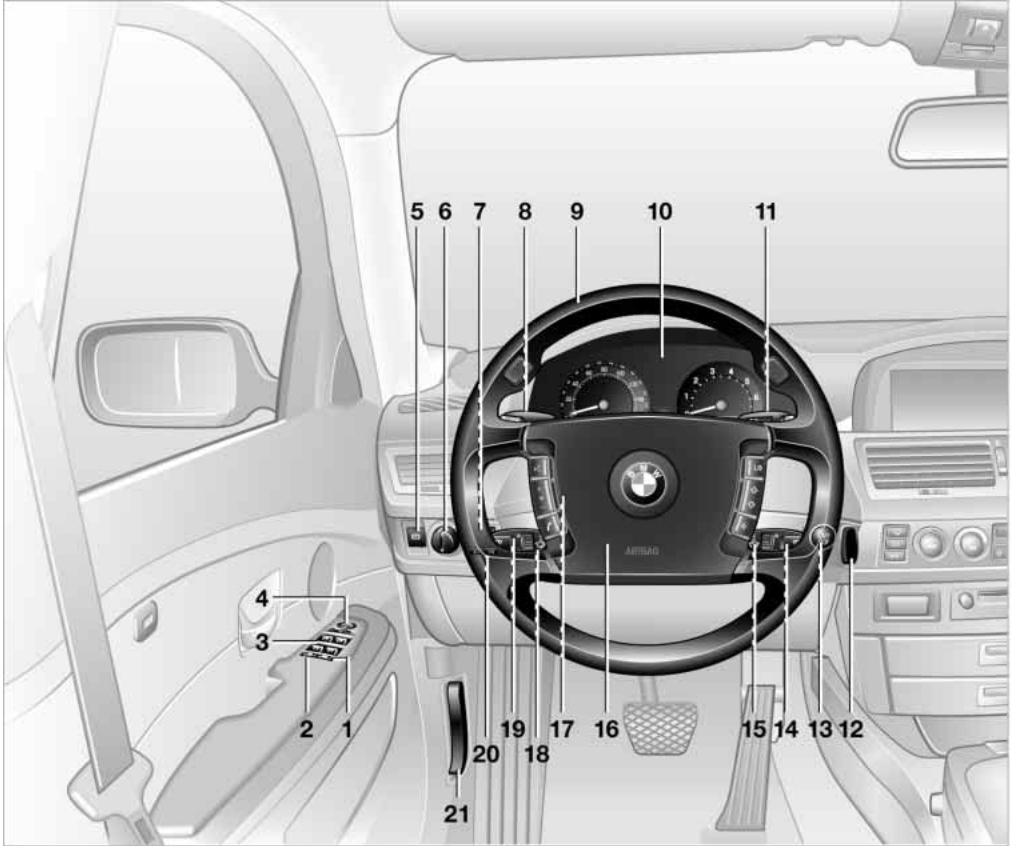
Cockpit

All around the steering wheel: controls and displays



- | | | | | | |
|---|----------------------------------|-----|---|--|-----|
| 1 | Roller sun blind for rear window | 112 | 6 | Parking lamps and low beams | 99 |
| 2 | Rear window safety switch | 42 | 7 |  Instrument lighting | 100 |
| 3 | Electric power windows | 41 | 8 |  Turn signal indicators | 69 |
| 4 | Exterior mirrors | 51 | |  High beams, headlamp flasher | 100 |
| 5 | Parking brake | 62 | | | |



Computer 84,
Check Control 82

Computer 84

Standing lamps 100

9 Steering wheel 16

10 Info Display 12

11 Automatic transmission lever 66

12 Ignition lock 60

13  Switching ignition on/off and starting the engine 60, 61

14  Windshield wipers 70



Rain sensor 70

15  PDC Park Distance Control 90

16 Horn: the entire surface

17  Steering wheel heater 52



Steering wheel adjustment 52

18  Unlocking luggage compartment 38

19  Programmable cruise control 71

20 Fog lamps 100



Front fog lamps

21 Releasing the engine hood 194

Info Display

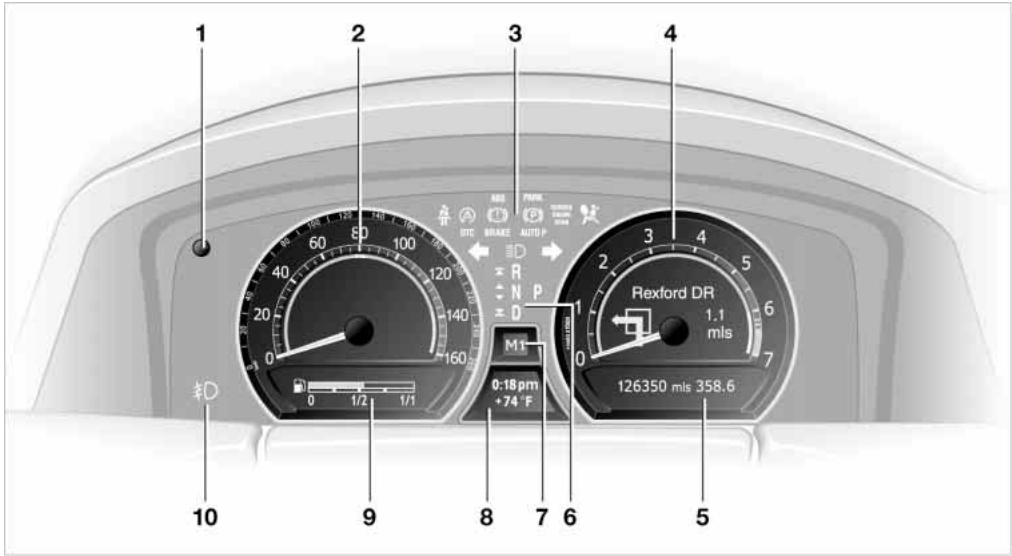

- 1 To view odometer display and reset trip odometer to zero [80](#)
- 2 Speedometer with display for
 - ▷ Programmable cruise control [71](#)
 - or
 - ▷ Active cruise control [73](#)
 - ▷ Speed limit [86](#)
- 3 Indicator and warning lamps [12](#)
- 4 Tachometer [80](#)
with destination guidance navigation system [139](#)
- 5 Indicator for
 - ▷ Computer [84](#)
 - or
 - ▷ Text message of the Check Control [82](#)
 - or
 - ▷ Voice command system [25](#)
- 6 Transmission range selection [66](#)
- 7 Automatic transmission program display [66](#)
- 8 Indicator for
 - ▷ Clock [88](#)
 - ▷ Outside temperature [80](#)
 - or
 - ▷ Indicator and warning lamps of the Check Control [82](#)
- 9 Computer with fuel gauge [85, 84](#)
- 10 Fog lamps [100](#)

Indicator and warning lamps

Technology that monitors itself

The indicator and warning lamps identified by the ● symbol are subjected to an operation check each time you switch on the ignition or start the engine. They each light up once for different periods of time.

When a malfunction occurs in a monitored system, the corresponding lamp will either fail to go out when the engine is started, or it will come on again during normal driving. For information on how you should respond when this happens, please refer to the pages indicated.



Please fasten safety belts ● 49



DSC Dynamic Stability Control ● 92



DTC Dynamic Traction Control 92



ABS Antilock Brake System ● 91



Parking brake/brake hydraulics/
DBC Dynamic Brake Control ● 62/ 197/ 93



Parking brake/brake hydraulics/
DBC Dynamic Brake Control for
Canadian models



Parking brake ● 62, 64



Parking brake 62, 64



Automatic parking brake –
Automatic Hold ● 63, 64



Service Engine Soon ● 199



Indicator lamp for Canadian
models



Airbags ● 97



Turn signal indicators 69



High beams/
headlamp flasher 100



Front fog lamps 100

Colors

The indicator and warning lamps can light up in different colors and combinations. The following section explains the significance of the individual colors as well as how you should respond when they appear.

- ▷ Red:
Stop the vehicle immediately or
an important reminder
- ▷ Red and yellow:
Continue to drive cautiously
- ▷ Yellow:
Have the system inspected at
the earliest opportunity
or
for your information
- ▷ Green:
For your information
- ▷ Blue:
For your information.

Indicator and warning lamps of the Check Control

Other indicator and warning lamps appear in the display 8 of the Info Display as necessary, accompanied by supplementary text, refer to Check Control, page 82.

Comfort area: controls and displays

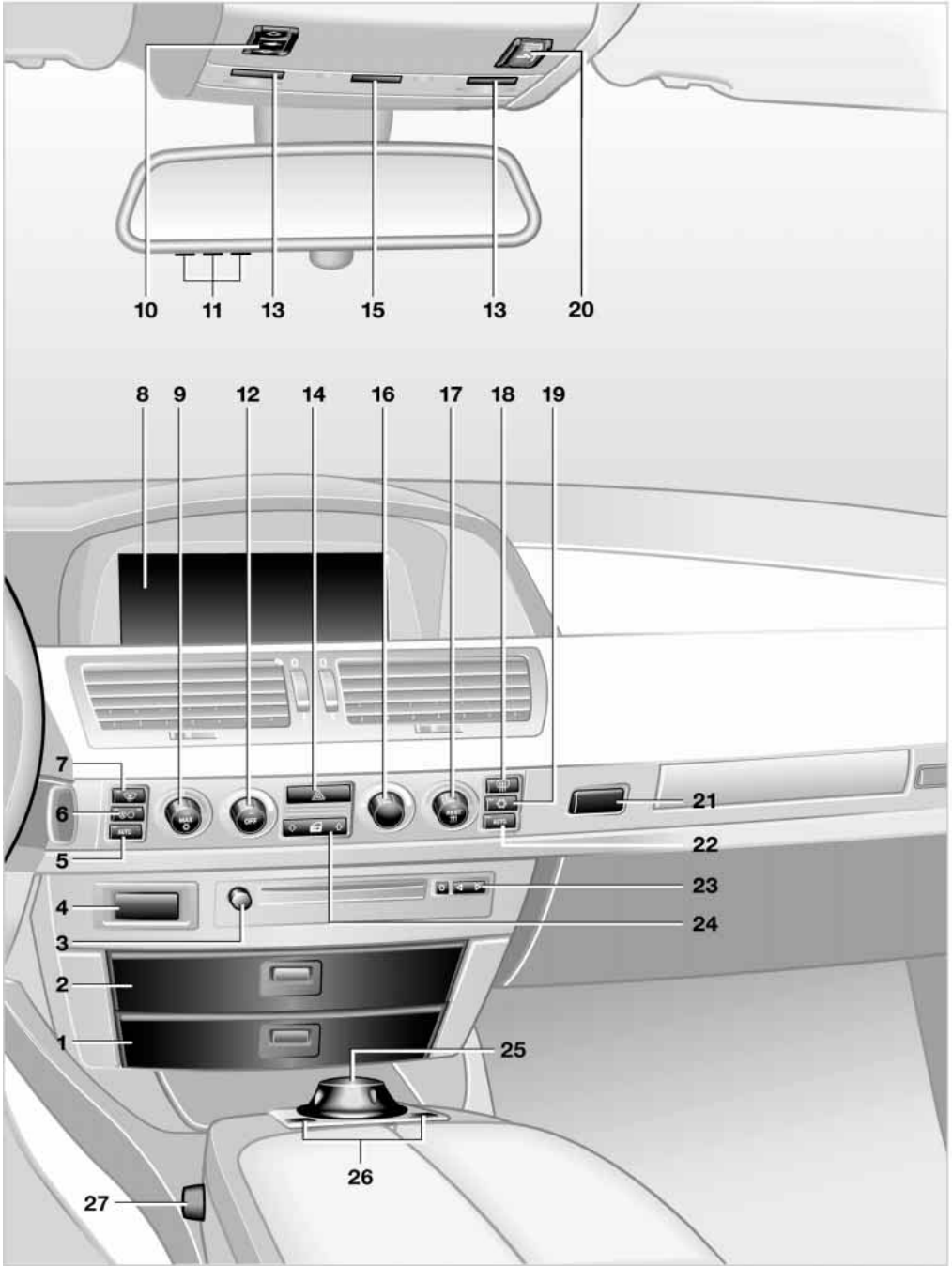

- 1 Glasses compartment [115](#)
- 2 Storage compartment [115](#)
- 3 Switching audio and video sources on/off and adjusting volume [149](#)
- 4 Telephone keypad, folding [176](#)
- 5 Automatic air distribution and supply, left side of passenger compartment [103](#)
- 6 Outside air/AUC Automatic recirculated-air control/recirculated air [104](#)
- 7 Defrosting windshield and windows and removing condensation [104](#)
- 8 Control Display [17](#)
- 9 Temperature, left side of passenger compartment: turn
Maximum cooling: press [104](#)
- 10 Glass roof, electric [42](#)
- 11 Memory buttons for integrated universal remote control [111](#)
- 12 Air supply, left side of passenger compartment: turn
Switching off automatic climate control: press [104](#), [106](#)
- 13 Reading lamps [101](#)
- 14 Hazard warning flashers
- 15 Interior lamps [100](#)
- 16 Air supply, right side of passenger compartment [103](#)
- 17 Temperature, right side of passenger compartment: turn
Residual heat mode: press [103](#), [105](#)
- 18 Rear window defroster
- 19 Air conditioning [104](#)
- 20 Starting an emergency call [177](#)
- 21 Opening the glove compartment
- 22 Automatic air distribution and supply, right side of passenger compartment [106](#)
- 23 Station/track search and CD, DVD [148](#)
- 24 Central locking system [36](#)
- 25 Controller [17](#)
- 26 Control Center buttons [17](#)

27 Seat adjustment [44](#)



Heated seats [49](#)



Active seat ventilation [50](#)



Active seat [51](#)



Seat, mirror and steering wheel memory [53](#)

Buttons on the steering wheel

Buttons are integrated on the steering wheel for fast operation of the following functions without being distracted from driving:

- ▷ The Steptronic of the automatic transmission
- ▷ Selected audio source functions
- ▷ Selected portable phone functions
- ▷ The voice command system
- ▷ Selected TV and DVD functions.

 The buttons on the steering wheel are only operational when the corresponding systems are switched on. ◀



Telephone:
Accepting calls, making calls, ending calls.



Volume.



Voice command system:
Switching on and off.



Fast forward/reverse:

- ▷ Radio
Press briefly: next stored station
Extended pressure: automatic tuning
- ▷ CD
Press briefly: skipping tracks
Extended pressure: fast forward/
reverse
- ▷ TV
Selecting program
- ▷ DVD
Searching for chapter.



Available for individual programming:
In the "Settings" menu, you can select the function of the button at the "◇ button" menu item, refer to page 52.



Steptronic:
Press briefly to proceed through a selection sequence consisting of the automatic program, the Sport program, and the manual mode, refer to page 66.



Steptronic: upshifting and downshifting, refer to page 67.

Control Center

The concept

The Control Center has been designed to avoid the unnecessary complexity created by an extended number of switches and controls. It consists of the controller and the Control Display.

The controller is used to select the functions that will appear on the Control Display. In addition, it also shows you Check Control messages, refer to page 82.

Controls

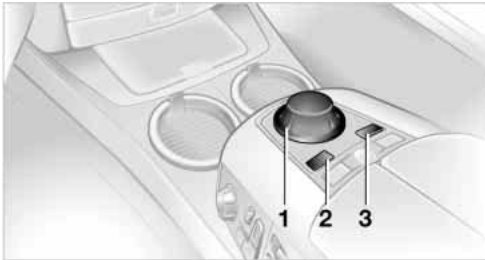

- 1 Controller: you operate all the functions in the Control Center by moving, turning and pressing.
 - ▷ If you move the controller, you feel the mechanical guides along the main direction of movement. This makes it easier for you to select the right main menus
 - ▷ If you turn the controller, you feel an electronically created rasterizing. This helps you to select the desired menu item
- 2 Button for opening the start menu from any menu item
- 3 Individual button assignment

 To avoid posing an unnecessary hazard, both to your own vehicle's occupants and to other road users: never attempt to use the controls or make adjust-

ments unless traffic and road conditions allow. ◀

The following introduction illustrates how easy it is to use the Control Center.

You can find detailed instructions describing how to use the individual systems in the separate sections.



Programming button function



You can assign specific individual functions to the programmable button. This feature then provides you with quick access to this function, allowing you to control it without undue distraction from road and traffic conditions.

1. Select "Settings" and press the controller



2. Select  and press the controller
3. Select " button". Continue to press the controller until the desired function appears:

- ▷ "Mode"

You can choose between the output sources radio/FM or AM, Compact Disc CD and CD changer. The precondition is that one of these sources has been activated

- ▷ "FM" or "AM"

Switching over between wavebands FM and AM, also refer to page 152

- ▷ "Short info"
Display of the help and supplementary texts of the active menu for approx. 10 seconds, refer to Assistance window on page 22.

You can select the displayed function using the button.

- ▷ The "Short info" function is not available in the rear. ◀

Control Display



To open the start menu:
Press the button



or

move the controller

- ▷ toward the currently active menu
- ▷ twice in one direction.

To switch off the Control Display, press the controller when you are in the start menu.



When the Control Display appears, you see the start menu for approx. 5 seconds, then the last active menu. You can have the display of the start menu deactivated at your BMW center. ◀

Selecting menu



Move the controller to select a menu, here: "Settings".

The menu appears on the screen as soon as you release the controller.

- ▷ You can move directly to a different menu by moving the controller in the corresponding direction. ◀

Selecting menu item

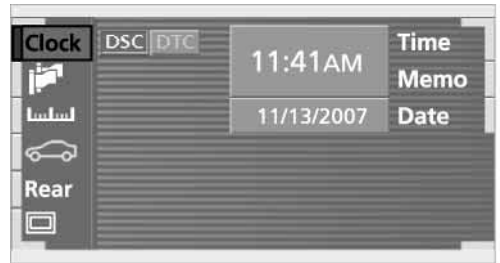

Turn the controller to select the menu item, here: "Clock".

Confirming selection or item

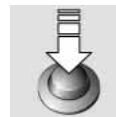

Press the controller to confirm the selection, here: "Clock".

Select the desired setting for adjustment from the menu item, here: "Time" and confirm.

Symbols and lists

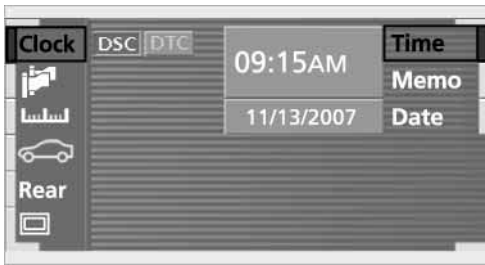

Settings

The first setting option for time is activated.

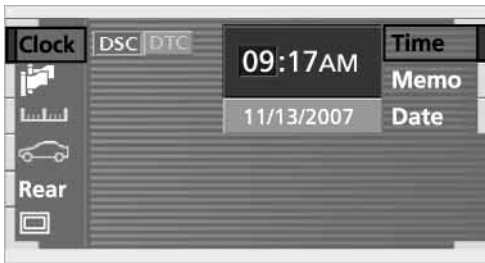

- ▷ Turn the controller to make the adjustment
- ▷ Press the controller to confirm – store – the new setting and to proceed to the next highlighted position to adjust.

Changing the menu page

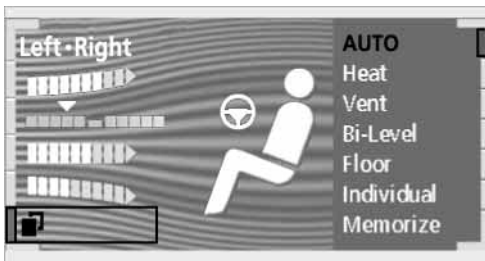

You can select individual pages in specific menus, here: "Climate".

Select the symbol and press the controller:

- ▣ To select the second page of the menu
- ▣ To return to the first page of the menu.

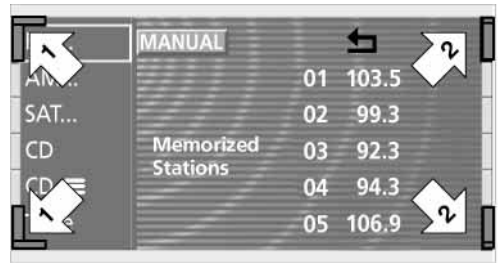



The symbols in the corners and edges of the Control Display have various functions:

- 1 **Corner symbols:**
These symbols take you to the next menu item or in a displayed list. To do so: turn the controller
- 2 **List symbols:**
Indicate that you can only move within the displayed list, here: stored radio stations.
Turn the controller to select an entry from the list.
To exit from the list, select the ↩ symbol and confirm. You can also leave the list by turning the controller to the left or right.

Symbols

- ▣ To select the second page
- ▣ To return to the first page
- ↩ To exit from the list
- ▣ To transfer the current display to the assistance window. For more detailed information on the assistance window, refer to page 22
- ↔ To transmit vehicle data to the BMW Service Center
- ▣ To set display units and formats, refer to page 88
- ▣ To change the language of the display texts, refer to page 88

-  To select settings for vehicle functions
-  To set the brightness of the screen, refer to page [89](#).

Menus in Control Display

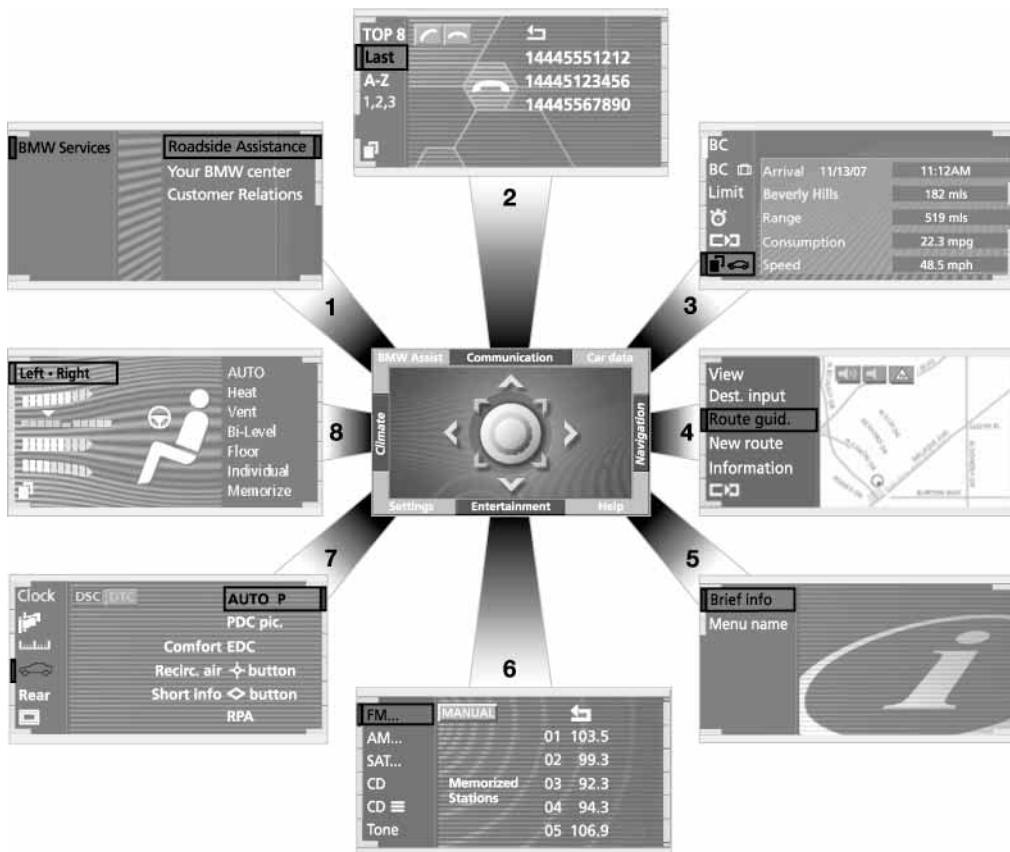

You can select from an extended range of functions and setting options:

- 1 BMW Assist [182](#)
- 2 Communication
 - ▷ Using the telephone [174](#)
 - ▷ Portable phone, refer to separate Owner's Manual
- 3 Car data
 - ▷ Computer [84](#)
 - ▷ Limit [86](#)
 - ▷ Stopwatch [87](#)
 - ▷ Service required [81](#)
 - ▷ Accessing Check Control messages [82](#)
- 4 Navigation [130](#)
- 5 Help
 - ▷ Brief help text displays [22](#)
 - ▷ Menu name for menu change
- 6 Entertainment
 - ▷ Radio [152](#)
 - ▷ CD [158](#), [160](#)
 - ▷ TV [163](#)
 - ▷ DVD [165](#)
- 7 Settings
 - ▷ Vehicle functions [52](#), [63](#), [90](#)
 - ▷ Time and date [88](#)
 - ▷ Language [88](#)

- ▷ Units of measure and display format [88](#)
 - ▷ Brightness [89](#)
 - ▷ Locking Control Center in rear [24](#)
- 8 Climate**
- ▷ Automatic climate control [102](#)
 - ▷ Heated seats [49](#)
 - ▷ Independent ventilation [109](#)

Assistance window*

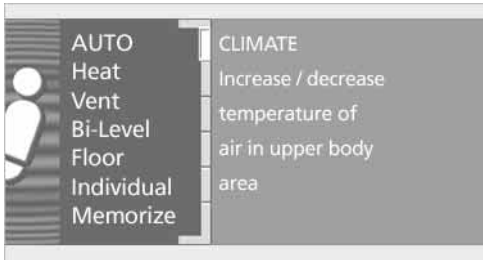

While you use the Control Center, the assistance window can provide you with a parallel display for the active system.

You can use it for displays of the following:

- ▷ Brief help and supplementary information texts for selected menu items
- ▷ A function selected in the "Car data" menu, refer to page [87](#)
- ▷ The route for vehicles with a navigation system, refer to page [131](#).

Help texts in assistance window



You can call up and also cancel displays containing help texts and supplementary

information on selected menu items in the assistance window.

1. Select "Help" from the start menu
2. Select "Brief info" menu and confirm. The help texts appear in the assistance window
3. Confirm again to hide the automatic display.

Showing menu name



You can program the system to display the menu name each time you proceed to a new menu.

1. Select "Help" from the start menu
2. Select "Menu name" and confirm.

Top and bottom status lines

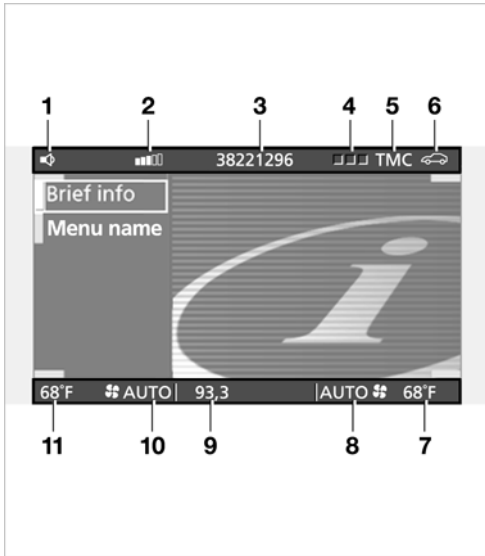

- 1 Hands-free mode active
 - 2 Portable phone reception strength
 - 3 Display field
 - ▷ of the telephone provider
 - ▷ of the entered/selected phone number
 - 4 Telephone status
 - ▷ Green: incoming or outgoing call
 - ▷ Red: no network available
 - ▷ Yellow: routed through alternate service network – roaming
 - 5 Traffic Message Channel activated – currently not available
 - 6 Status Check Control [82](#)
 - ▷ Yellow: priority 2 – the symbol flashes briefly. You can use the "Car data" menu to have the status report shown on the Control Display
 - ▷ Red: priority 1 – these messages appear immediately, accompanied by a gong and a flashing symbol
- Status Service Interval Display [81](#)
- ▷ Red: at least one service interval has been exceeded

- 7 Temperature selection display, right side of passenger compartment
- 8 Air supply, right side of passenger compartment
- 9 Entertainment: display for radio, CD, TV, DVD
- 10 Air supply, left side of passenger compartment
- 11 Temperature selection display, left side of passenger compartment

Assistance window

The status lines in the assistance window show the following:

- ▷ Outside temperature
- ▷ Navigation system destination
- ▷ Time
- ▷ Date.

Control Center in rear*

Rear screen



Folding open rear screen:

1. Swing folding arm upward until it engages
2. Fold open rear screen.

The rear screen is ready for operation.

Folding down rear screen:

1. Align rear screen straight
2. Fold rear screen downward; folding arm unlocks
3. Swing folding arm downward.

 Swing the rear screen downward when the ski bag is used, as otherwise it could be damaged. Do not swing the rear screen up or down with the beverage holders open, as otherwise it could be damaged. ◀

 The rear screen switches off automatically when it is swung downward. Some functions are not available on the rear screen, e.g. the BMW Assist function can only be operated in the front Control Display. Some functions only permit limited operation on the rear screen, e.g. the speed limit can only be displayed. Setting is carried out via the front controller, refer to page 86. ◀

Controller/buttons

The controller and buttons are located on the center armrest.

Rear lock

The available functions are operated with the respective controller. In the Control Center, you can limit or deactivate operation of the rear screen.

1. Select the "Settings" menu and confirm
2. Select "Rear" and confirm



3. Set operation of rear screen:
 - ▷ Select "Limited Release" and confirm to lock the functions used in the front Control Display
 -  When headphones are connected, all audio and video functions continue to be selectable in the rear, with the exception of the audio or video source activated in the front Control Display. ◀

- ▷ Select "None Release" and confirm to switch off the rear screen
- ▷ Select "Full Release" and confirm to switch off all locks
- ▷ Select "Release" menu and confirm to switch individual menus on or off:
 - Communication menu: select "Comm." and confirm.
 - Entertainment menu: select "Entertainm." and confirm.

Headphones

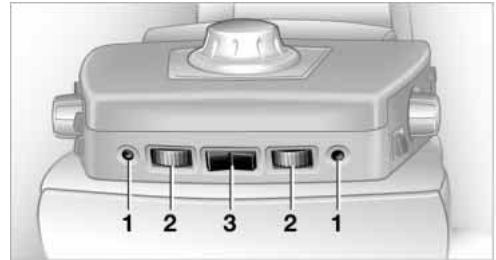

- 1 Headphone jack
- 2 Adjusting volume
- 3 Station scan/track search
 - ▷ Station scan
 - ▷ Music track search for CD, chapter search for DVD changer
 - ▷ Selecting TV channels.

Headphones are only intended for passengers in the rear seats. Please check with local regulations regarding use of headphones.

Voice command*

Voice command system

The concept

The voice command system allows you to control operation of various vehicle systems without ever removing your hands from the steering wheel. The system operates on the basis of voice commands that you will learn easily after using them a few times. In many cases, the voice command system supports you with announcements or questions while you are making your entries.

The voice command system transforms your oral commands and dialog answers into control signals for the selected systems.



Please take the time to acquaint yourself with how a particular system operates before proceeding to control it using the voice command system. ◀

Symbols used



These sections contain information on using the voice command system.

›...‹ Verbal instructions to use with the voice command system.

››...‹‹ Identifies the answers generated by the voice command system.

Systems available for use with voice command

- ▷ ›Telephone‹, refer to page 174
- ▷ ›Navigation‹, refer to page 130
- ▷ ›Radio‹, refer to page 152
- ▷ ›CD‹, refer to page 158
- ▷ ›CD changer‹, refer to page 160
- ▷ ›Notepad‹, refer to page 27
- ▷ ›TV‹, refer to page 163
- ▷ ›DVD‹, refer to page 165.

Either the system that you are now operating or any current error messages will appear in the Info Display, refer to page 26.

Speaking commands

Activating voice command system

Briefly press the  button on the steering wheel.

A signal tone and "SVS active" in the Info Display, refer to page 26, indicate that the system is ready for use. You are automatically in the main menu.

From here, you can call up all the equipment that can be operated.

Canceling voice command system

Briefly press the  button on the steering wheel

or

 ›Cancel‹.

In dialogs in which any text can be spoken, e.g. names, notes, canceling is only possible using the  button.



The system automatically switches over to its telephone mode if you receive a call during voice command. "SVS off" appears in the Info Display, refer to page 26. ◀

Voice commands

The voice command system operates on the basis of specific, predefined commands; these commands should be spoken precisely as indicated. You can have the possible commands read back at any stage. To do so, say the command ›Options‹.

In addition to the commands described, there are often other commands that run the same function. Instead of ›Options‹, you can, for example, also say ›What now‹.

More detailed commands such as ›Change scale‹ instead of ›Scale‹ are also often possible.

Short commands

With the ›Main menu‹ level, you can run certain functions directly with short commands, refer to page 28, without having to open an equipment level.

For example, if you want to dial a phone number, you do not have to say

 ›Telephone‹

rather you can say directly

-  1. ›Dial number‹
2. Enter the phone number.

Special commands

Special commands are available for specific systems. In this Owner's Manual you

will find these commands in the sections describing the individual systems.

 Operation with the voice command system is always indicated with this pictograph.

Displays in the Info Display

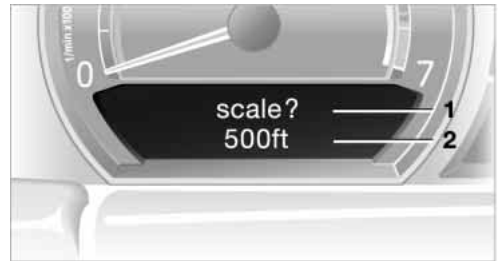

The Info Display shows you what the voice command system has understood in line 2, while also indicating which voice command or question is currently active in line 1. In addition, any error messages are also displayed.

Selecting the navigation scale - an example

Start the dialog:

Briefly press the  button on the steering wheel.

You say	The voice command system replies	Info Display screen contents
		"SVS active"
›Change scale‹	››Please enter the desired scale‹‹	"scale ? change scale"
›Scale 500 feet‹		"ok 500 ft"

Volume adjustment

You can adjust the volume for the instructions from the voice command system:



Turn the button during an instruction/announcement to select the desired volume.

Instructions/announcements from the voice command system will continue at this volume level, even if the other audio sources are set to minimum volume.

 The system automatically selects your individual volume setting each time you unlock the vehicle using your personal remote control. ◀

Notes

 Do not use the voice command system to make emergency calls. Your voice and habitual tone could be affected by stressful situations, as a result of which the process of establishing the telephone connection could be unnecessarily delayed. Instead, use the emergency call button near the interior rearview mirror, refer to page 177. ◀

Environmental conditions

The voice command system uses a special hands-free microphone located in the front of your vehicle's headliner. Although the system is designed to filter out ambient noise, you can help ensure that your commands will be understood by observing the following instructions:

- ▷ Speak smoothly and clearly, at a normal volume. Do not place any unusual stress on individual syllables, and avoid pauses
- ▷ Do not speak while the voice command system is talking
- ▷ Keep the doors, windows and glass roof closed to prevent interference from ambient noise
- ▷ Avoid other sources of noise in the vehicle while speaking, and ask other vehicle occupants to refrain from talking while you are using the system
- ▷ The hands-free microphone is aimed toward the driver. This means that the system might be unable to register the voices of other vehicle occupants properly.

The notebook

Recording a note

 ›Record note◁.

You can store approx. ten minutes of spoken text – either as a single entry or as multiple entries of any desired length.

To terminate recording:

Press the  button for a long period.

 When recording notes, the voice command system does not respond to the ›Cancel◁ command. The text checking function for command words is deactivated in this case so that you can speak any desired text for your notes. This feature saves you from having to concentrate on avoiding any command words. ◀

Listening to a notebook entry

To listen to recorded notebook entries:

-  1. ›Read out◁
- Approximately the first 3 seconds of the first note are read aloud
2. Following the inquiry ››Note and next?◁ select the desired function
- ▷ To listen to the entire note: ›Read out◁
 - ▷ To listen to the next notebook entry: ›Next◁
 - ▷ To listen to the entry again: ›Back◁ or ›Repeat◁.

Deleting notes

-  1. ›Edit◁
2. ›Delete◁.

Clearing the notebook

To delete all contents from the notebook:

-  1. ›Notepad◁
2. ›Delete◁.

Standard commands

The standard commands available for use with all controlled systems are the same.



On delivery, the ›Standard dialog‹ is set to simplify familiarization with the voice command system. ◀

Function	Command
To repeat last message issued by the voice command system	›Repeat‹
To terminate the voice command system	›Cancel‹
To set comprehensive instructions and error reports	›Standard dialog‹
To set brief instructions and error reports	›Short dialog‹
To call up information on individual items of equipment	›Help‹
To provide you with a listing of the commands available for the selected system. A corresponding list simultaneously appears in the Info Display, refer to page 26	›Options‹
To open the main menu	›Main menu‹

Short commands

Notebook

Function	Command
To record a note	›Record note‹
To listen to notebook entry	›Read out note‹

Navigation

Function	Command
To switch on the voice output	›Message on‹
To switch off the voice output	›Message off‹
To select destination from address book	›Select destination‹
To change scale	›Scale‹
To start the destination guidance	›Route guidance on‹
To call up information on the current position or destination	›Information‹
To request addresses	›Address book‹
To open the map view	›Map‹

Entertainment

Function	Command
To switch on radio	›Radio on⟨
To switch off audio sources and TV	›Audio off⟨
To select FM waveband	›FM⟨
To select AM waveband	›AM⟨
To select radio stations	›Frequency selection⟨
To select a stored radio station	›Station⟨
To start CD	›CD on⟨
To select a CD	›CD 1 ..6⟨
To start TV	›TV on⟨
To start DVD	›DVD on⟨
To select a DVD	›DVD 1 ..6⟨

Telephone

Function	Command
To switch on portable phone	›Telephone on⟨
To dial telephone number	›Dial number⟨
To redial	›Redial⟨
To select from the phone book	›Dial name⟨
To make a new entry in the phone book	›Save name⟨
To have the entries of the telephone book read out	›Read out telephone book⟨



The background of the page is a blurred, high-angle view of a car's interior, showing the steering wheel, dashboard, and center console. The image is out of focus, with a blue color cast.

Controls

This chapter is intended to provide you with information for complete control of your vehicle. Its extensive array of features and accessories, both for driving and for your own safety, comfort and convenience, are described here.

Opening and closing

Keys/remote control



- 1 Remote controls with integrated key; they determine the functions of the Key Memory, refer to page 54.
You can mark the remote controls using the colored labels you received on taking delivery of the vehicle
 - ▶ Each remote control contains a long-life rechargeable battery or in the case of Comfort Access a battery. The battery is automatically charged in the ignition lock while the vehicle is being driven.
 If you have any remote controls that are not being used on a regular basis, you should therefore remember to recharge these units by using them to drive the vehicle for an extended period at least once a year, refer to page 33.
Battery replacement with Comfort Access, refer to page 35. ◀
- 2 Spare key for storage in a safe place, such as in your wallet. This key is not intended for constant use
- 3 Adapter for spare key
The adapter can be used to store the spare key. It can be stored in the place provided within the luggage compartment lid-mounted onboard tool kit to ensure that it will always be available, refer to page 200. You can find more detailed information on using the adapter in the section Using the spare key adapter

Removing the key from the remote control



Press button 1 to release the key.
You can use the integrated key to unlock and lock the following:

- ▶ The storage compartment under the front armrest
- ▶ The driver's door
- ▶ The luggage compartment lid.

Within the storage compartment you will also find the switch for locking the luggage compartment separately, refer to page 37.

If you lock the storage compartment and only turn over the remote control, for example when leaving the vehicle for hotel valet parking etc., no access is possible via the luggage compartment lid.

Using the spare key adapter

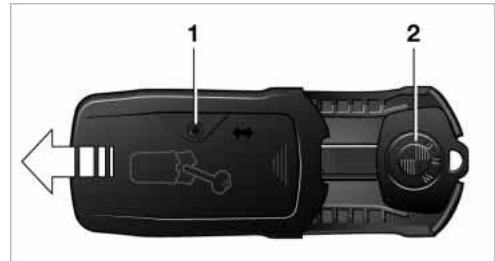

You will need the adapter to activate the ignition and to start the vehicle with the spare key.

Press lock button 1, slide up the cover and insert the spare key 2 in the adapter. Close

the cover and insert the adapter in the ignition lock.

Central locking system

The concept

The central locking system is ready for operation whenever the driver's door is closed. This simultaneously engages and releases the locks on the following:

- ▷ Doors
- ▷ Luggage compartment lid
- ▷ Fuel filler door.

The central locking system can be operated from the outside

- ▷ via the remote control
- ▷ via the driver's door lock
- ▷ with Comfort Access via the door handle

and from inside via the button for the central locking system.

When the system is locked from inside, the fuel filler door remains unlocked, refer to page 36.

The anti-theft system is automatically activated whenever you activate the central locking system from outside the vehicle. The alarm system is armed/disarmed at the same time.

In an accident, the central locking system automatically unlocks the vehicle. In addition, the hazard warning flashers and interior lamps switch on.

Opening and closing: from outside

Using the remote control

When you engage/release the vehicle's locks, you simultaneously activate/deactivate the anti-theft system, arm/disarm the alarm system and switch the interior lamps on/off.

In addition, the remote control offers you another function:

- ▷ Panic mode
In case of danger, you can trigger an alarm.



You can have various confirmation signals programmed into the system to verify that the vehicle has been locked securely. ◀

Remote control



- 1 To unlock, convenience opening mode and alarm system
- 2 To lock and secure, switch off tilt alarm sensor and interior motion sensor, switch on interior lamps and door-mounted proximity lamps
- 3 To open the luggage compartment lid
- 4 To switch on interior lamps, activate panic mode



Because any persons or animals left unattended in a parked vehicle could lock the doors from the inside, you should always keep the remote control with you; this precaution ensures that you will remain able to unlock the vehicle from the outside at all times. ◀



When it is no longer possible to lock the vehicle via the remote control, the battery is discharged. Use this remote control during an extended drive; this will recharge the battery, refer to page 32. In the event of a system malfunction, please contact your BMW center, which is also your source for replacement keys. ◀

Unlocking

Press button 1 .

The interior lamps and the door-mounted proximity lamps come on.

Press the button once to unlock the driver's door only; press a second time to unlock all remaining doors as well as the luggage compartment lid and the fuel filler door.

Convenience opening mode

Hold button 1  pressed. The windows and the glass roof open. The glass roof will not be retracted if it is already in its raised position.

Locking and securing

Press button 2  LOCK.

Switching off the tilt alarm sensor and interior motion sensor

Press button 2  LOCK once again directly after locking.

For more detailed information, refer to page 40.

Switching on interior lamps and door-mounted proximity lamps

If the vehicle is locked, press button 2  LOCK.

Switching on the interior lamps

Press button 4 .

You can also use this function to locate your vehicle in parking garages etc.

Panic mode

By pressing and holding button 4  for more than approx. two seconds, you can trigger the alarm system in response to any impending danger.

To switch off the alarm: press any of the buttons.

Opening the luggage compartment lid

Maintain pressure on button 3  for approx. 1 second.

The luggage compartment lid opens, regardless of whether it was previously locked or unlocked.

 During opening, the luggage compartment lid pivots upward and to the rear. Ensure that adequate clearance is available before opening.

To avoid being inadvertently locked out, never lay the remote control down in the luggage compartment. If the vehicle is locked, the luggage compartment lid is also locked again when closed. ◀

Automatic luggage compartment lid operation*

Opening the luggage compartment lid

Maintain pressure on button 3  for approx. 1 second.

The luggage compartment lid opens all the way, regardless of whether it was previously locked or unlocked.

To interrupt the opening process:

Press the button again while opening is in progress.

 During opening, the luggage compartment lid pivots upward and to the rear. Ensure that adequate clearance is available before opening.

To avoid being inadvertently locked out, never lay the remote control down in the luggage compartment. If the vehicle is locked, the luggage compartment lid is also locked again when closed. ◀

Comfort Access*

Carry the remote control on your person if you want to use the Comfort Access.

Unlocking

- ▷ Pull a door handle or
- ▷ press the button on the outside of the luggage compartment lid.

 Only the door of the door handle you have pulled is opened.

You unlock the other doors from the inside

using the central locking system button, refer to page 36. ◀

Locking and securing

With the driver's door closed, press a door handle.



You can have various confirmation signals programmed into the system to verify that the vehicle has been locked securely. ◀



If a remote control is detected in the interior, the vehicle is unlocked again or not locked in the first place. ◀

Opening the luggage compartment lid

Press the button on the outside of the luggage compartment lid, refer to page 37.



During opening, the luggage compartment lid pivots upward and to the rear. Ensure that adequate clearance is available before opening.

If a remote control is detected in the luggage compartment after the luggage compartment lid has been closed, the luggage compartment lid opens again. ◀

Changing battery

Replace the battery if it is no longer possible to unlock or lock the vehicle.



1. Take the key out of the remote control, refer to page 32
2. Press in the detent, refer to arrow 1, e.g. with the key
3. Remove the cover of the battery compartment, refer to arrow 2

4. Insert a battery of the same type with the positive side facing upwards

5. Press the cover to close it.



Return used batteries to a recycling point or your BMW center. ◀

Malfunctions

External systems or devices may cause local interference in the functions of the remote control.

Should the remote control unit fail to operate owing to interference of this kind, you can respond by using the key to unlock your vehicle at one of the doors.

In the event of a system malfunction, please contact your BMW center, which is also your source for replacement keys.

When it is no longer possible to lock the vehicle via the remote control, the battery is discharged. Use this remote control unit during an extended drive; this will recharge the battery, refer to page 32.

For US owners only

The transmitter and receiver units comply with part 15 of the FCC/Federal Communication Commission regulations. Operation is governed by the following:

FCC ID: LX8766S
LX8766E
LX8CAS
LX8CAS2

Compliance statement:

This device complies with part 15 of the FCC Rules. Operation is subject to the following two conditions:

- ▶ This device may not cause harmful interference, and
- ▶ this device must accept any interference received, including interference that may cause undesired operation.



Any unauthorized modifications or changes to these devices could void the user's authority to operate this equipment. ◀

Using the key

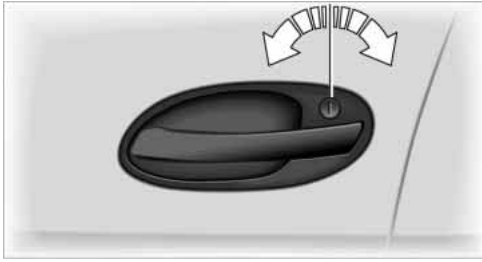

One turn of the key in the driver's door lock unlocks the driver's door only.

Turning the key a second time unlocks all of the remaining doors, the luggage compartment lid and the fuel filler door.



You can have various confirmation signals programmed into the system to verify that the vehicle has been locked securely. ◀

Convenience operation

You also have the option of operating the windows and the glass roof from the driver's door lock.

- ▷ To open:
With the door closed, turn the key to the Unlock position and hold it there
- ▷ To close:
With the door closed, turn the key to the Lock position and hold it there.



Watch during the closing process to be sure that no one is injured. Releasing the key stops the operation. ◀



Manual operation

in the event of an electrical malfunction

You can turn the key all the way to the right or left in the door lock to engage or release the locking mechanism in the driver's door.

Opening and closing: from the inside



You can operate the central locking system with this button when the driver's door is closed. The doors and luggage compartment lid are unlocked  or locked  only. The anti-theft system is not activated.

Also, the fuel filler door remains unlocked to allow refueling.



If the remote control, refer to page 34, or Comfort Access, refer to page 34, have been used to unlock only the driver's door and you press the  button when the driver's door is open, the other doors, the luggage compartment lid, and the fuel filler door are unlocked.

If the driver's door is closed, pressing the  button locks it. ◀



You can also have the system programmed to activate the central locking system automatically whenever the vehicle is set in motion, or when a specific interval elapses after it is unlocked, provided that neither the doors nor the luggage compartment lid are opened in the meantime. This can be adjusted to be key-specific. ◀

Unlocking and opening the doors

- ▷ Either unlock the doors together with the button for the central locking system and then pull the release handle above the armrest or
- ▷ pull the release handle for each door twice: the first pull unlocks the door, and the second one opens it.



When the low beams are switched on, the interior door handles are also

lighted. The intensity of the lighting is adjusted using the instrument lighting control, refer to page 100. ◀

Engaging the locks

- ▷ Use the central locking button to lock all of the doors simultaneously, or
- ▷ press the individual safety lock buttons down. To prevent the driver from being inadvertently locked out of the vehicle, the lock button on the driver's door automatically extends again after a brief period if the door remains open.

! Because any persons or animals left unattended in a parked vehicle could lock the doors from the inside, you should always keep the remote control with you; this precaution ensures that you will remain able to unlock the vehicle from the outside at all times. ◀

Doors

Soft Close Automatic*

Apply gentle pressure to the door to close it. The closing process will then be carried out automatically.

! To avoid injuries, ensure that the door's travel path is completely free and clear before closing. ◀

Luggage compartment lid

Opening from outside

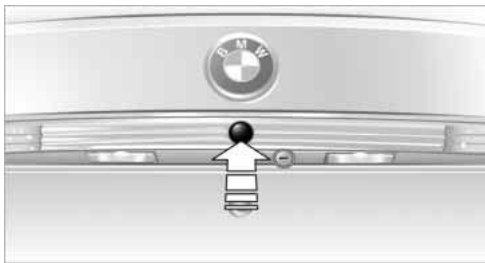

Press button. The luggage compartment lid opens.

▷ During opening, the luggage compartment lid pivots upward and to the rear. Ensure that adequate clearance is available before opening. ◀

The lock

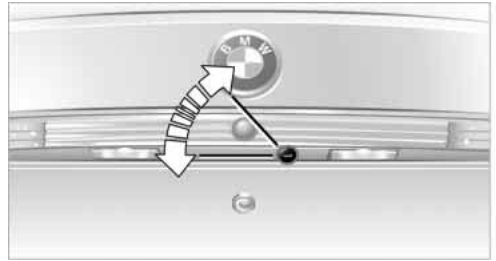

All of the vehicle's keys fit the luggage compartment lid lock located in the license plate recess.

Opening separately

Insert the key in the luggage compartment lid's lock and turn it all the way to the right – the lid opens.

▷ To avoid being locked out inadvertently, avoid laying the remote control down in the luggage compartment. The luggage compartment is locked again as soon as you close the lid. If you use the key to unlock the luggage compartment lid while the alarm system is armed, the alarm will be triggered. Switching off the alarm, refer to page 40. ◀

Securing separately

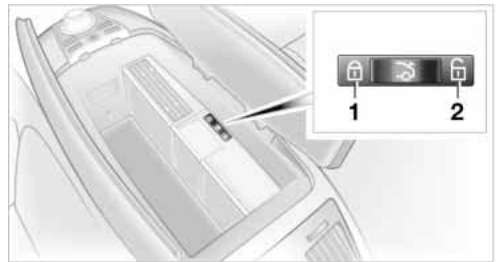

The switch position will vary according to the individual vehicle's equipment level.

- 1 Luggage compartment lid locked
 - 2 Luggage compartment lid unlocked
- Push the switch into position **1**. This locks the luggage compartment lid and disconnects it from the central locking system.

If you then lock the storage compartment in the center armrest before handing over only the remote control when leaving the vehicle for valet parking, etc., this will prevent unauthorized access to the vehicle through the luggage compartment, refer to page [32](#).

Manual operation

in the event of an electrical malfunction
Refer to section on Opening separately.

Opening from inside



You can use this button to open the luggage compartment lid when the vehicle is stationary. This is not possible, if the luggage compartment lid has been locked separately.

Closing



A recess has been incorporated into the inside trim on the luggage compartment lid to make it easier to pull down.

Comfort Access*

 If a remote control is detected in the luggage compartment after the luggage compartment lid has been closed, the luggage compartment lid opens automatically.

During opening the luggage compartment lid pivots upward and to the rear. Ensure that adequate clearance is available before opening. ◀

Automatic Soft Close feature

To close the luggage compartment lid, merely press it down gently. The closing process will then be carried out automatically.

 To avoid personal injury, always ensure that no individuals are within the luggage compartment lid's travel range when closing.

Operate the vehicle only when the luggage compartment lid is completely closed. Otherwise, exhaust fumes could penetrate the interior of the vehicle. If special circumstances should make it absolutely necessary to operate the vehicle with the luggage compartment lid open:

- ▷ Close all windows and the glass roof
- ▷ Adjust the automatic climate control's blower to supply a high rate of airflow, refer to page [104](#). ◀

Automatic luggage compartment lid operation*

Opening

The luggage compartment lid opens all the way, when you

- ▷ press the button next to the steering column
- ▷ press the button on the outside of the luggage compartment lid, refer to page [37](#)
- ▷ press button **3**  on the remote control unit, refer to page [34](#).

 During opening, the luggage compartment lid pivots upward and to the

rear. Ensure that adequate clearance is available before opening. ◀

Closing



The luggage compartment lid closes automatically when you

- ▷ press the button or
- ▷ press the button on the outside of the luggage compartment lid, refer to page 37.

 The luggage compartment lid immediately stops opening or closing if you hold it in place by hand. ◀

 To avoid injuries, be sure that the travel path of the luggage compartment lid is clear when it is closed, as with all closing procedures.

Operate the vehicle only when the luggage compartment lid is completely closed.

Otherwise, exhaust fumes could penetrate the interior of the vehicle. If special circumstances should make it absolutely necessary to operate the vehicle with the luggage compartment lid open:

- ▷ Close all windows and the glass roof
- ▷ Adjust the automatic climate control's blower to supply a high rate of airflow, refer to page 104. ◀

Comfort Access*

 If a remote control is detected in the luggage compartment after the luggage compartment lid has been closed, the luggage compartment lid opens automatically.

During opening the luggage compartment lid pivots upward and to the rear. Ensure

that adequate clearance is available before opening. ◀

Manual operation

in the event of an electrical malfunction

Use the key to unlock the luggage compartment lid, refer to page 37, and then slowly open or close it, taking care to avoid abrupt motion in the process.

Emergency release



This lever releases the luggage compartment lid from inside the luggage compartment.

Luggage compartment

Net*

You can use the net to store smaller objects on the bulkhead separating the luggage compartment from the rear seats.

 Do not stow objects behind the side trim panels on the left and right in the luggage compartment, as otherwise the electrical parts could overheat and be damaged. ◀

Alarm system

The concept

The vehicle alarm system responds:

- ▷ When a door, the hood, or the luggage compartment lid is opened
- ▷ To movement in the vehicle interior: interior motion sensor

- ▷ To a change in the vehicle's tilt if someone attempts to steal the wheels or tow the vehicle
- ▷ To interruption of battery voltage.

The system responds to unauthorized vehicle entry and attempted theft by simultaneously activating:

- ▷ An acoustic alarm, which lasts for a period of approx. 30 seconds
- ▷ The hazard warning flashers for approx. five minutes
- ▷ The high beams, which flash on and off in the same rhythm.

Arming and disarming the alarm system

When you lock or unlock the vehicle, either with the remote control unit or at the door lock, the alarm system is armed or disarmed at the same time.

The system indicates that it has been correctly armed by switching on the hazard warning flashers for a single cycle and by emitting an acoustic signal.



You can have different acknowledgment signals set to confirm arming and disarming. ◀

You can also open the luggage compartment lid with the system armed using button 3  on the remote control, refer to page 34. When you close the lid, the system is rearmed.



Pressing the Panic mode button for a longer period triggers the alarm, refer to page 34. ◀

To deactivate the alarm

- ▷ unlock the vehicle using the remote control, refer to page 34
- ▷ insert the remote control all the way into the ignition lock, engaging the detent.

Indicator lamp displays

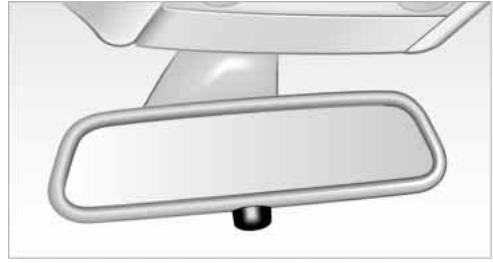

- ▷ The indicator lamp below the interior rearview mirror flashes continuously: the system is armed
- ▷ The indicator lamp flashes when the system is armed: door(s), the hood or luggage compartment lid are not completely closed. Even if you do not close the alerted area, the system begins to monitor the remaining areas, and the indicator lamp flashes continuously after 10 seconds. However, the interior motion sensor is not activated
- ▷ The indicator lamp goes out when the system is disarmed: no manipulation or attempted intrusions have been detected in the period since the system was armed
- ▷ The indicator lamp flashes when you disarm the system before the remote control unit is inserted in the ignition lock, but for no more than roughly 5 minutes: an attempted entry has been detected in the period since the system was armed.

Following triggering of an alarm, the indicator lamp will flash continuously.

Avoiding unintentional alarms

The tilt alarm sensor and interior motion sensor may be switched off at the same time. You can do this to prevent a false alarm from being triggered in garages with elevator ramps, for instance, or when the vehicle is transported by trailer or train:

Lock, i.e. arm twice; press button 2  LOCK on the remote control twice in succession, refer to page 34.

The indicator lamp lights up briefly and

then flashes continuously. The tilt alarm sensor and the interior motion sensor are switched off as long as the system is armed.



If you desire, the

- ▷ tilt alarm sensor
- ▷ interior motion sensor

can be switched off permanently. Please contact your BMW center for assistance. ◀

Interior motion sensor

In order for the interior motion sensor to function properly, the windows and glass roof must be completely closed.

Be sure to deactivate the interior motion sensor, refer to section on Avoiding unintentional alarms, when you wish to leave the windows or glass roof open.

Windows

Opening and closing windows



From radio mode on:

- ▷ Press the switch until you feel resistance:
The window continues to move downward as long as you continue to hold the switch
- ▷ Briefly press the switch beyond the resistance point:
The window moves downward automatically. Briefly press the switch again to stop the opening movement.

You can close the windows in the same manner by pulling the switch.

After switching off the ignition

You can still operate the power windows:

- ▷ For approx. 15 minutes with the remote control unit in the radio mode
- ▷ For approx. 1 minute in position 0 or with the remote control unit disengaged.

To open, press the switch beyond the resistance point.



When leaving the vehicle parked, always remove the remote control from the ignition lock and close the doors; this precaution prevents children from operating the power windows and injuring themselves, etc. ◀

For information on using the convenience operation mode at the door lock or with the remote control, refer to page 34 or 36.

Safety feature

If the force rises beyond a predefined threshold during closing, the system will stop moving the window prior to lowering it slightly.



Despite this safety feature you should always inspect the window's travel path prior to closing it, as the safety system might fail to detect certain kinds of obstructions, such as very thin objects, and the window would continue closing.

Pulling the switch beyond the resistance point and holding it limits the response of the safety feature. Under these conditions the window will respond to forces beyond a defined threshold by only opening several millimeters.

If you again pull the switch past the resistance point and hold it in position within a period of roughly 4 seconds, the safety feature will be deactivated. ◀





When you close the windows they will slow down as they approach the end of their travel; this is to allow the safety feature to respond more precisely to any obstructions encountered in this critical range. ◀

Safety switch



With the safety switch, you can prevent the rear windows from being opened or closed via the switches in the rear passenger area, by children, for example. The same applies to adjusting the electric rear seats, refer to page 46 and the electric rear head restraints, refer to page 48, as well as to the operation of the roller sun blinds from the rear, refer to page 112. The indicator lamp lights up when this safety feature is activated.

 Press the safety switch whenever children are riding in the rear of the vehicle. Careless use of the power windows can lead to injury. ◀

 So that you can deactivate the function again, the remote control must be inserted in the ignition lock or, with Comfort Access, the radio position must be switched on. ◀

After installing accessories

After installing any accessory – such as a clamp-on antenna for a portable phone – within the window's travel range, you will need to have the system reinitialized for use under the new conditions. Please contact your BMW center for assistance.

Glass roof, electric*

 To prevent injuries, exercise care when closing the glass roof and keep it in your field of vision until it is shut. When leaving the vehicle, always disengage the remote control in the ignition lock

and close the doors to prevent children from operating the roof and injuring themselves, etc. ◀

Raising, opening, closing

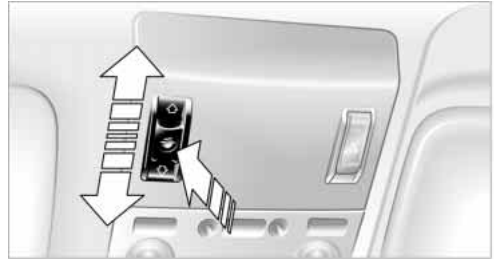

From radio mode on, press the switch, or slide it in the desired direction up to the resistance point.

After switching off the ignition

You can still operate the roof:

- ▷ For approx. 15 minutes with the remote control in the radio mode
- ▷ For approx. 1 minute in position 0 or with the remote control disengaged.

The headliner insert slides back somewhat when you raise the roof. When the roof is opened the headliner retracts with it.

 Do not use force to close the headliner insert with the roof in its raised position, as damage to the mechanism could result. ◀

For information on using the convenience operation mode at the door lock or with the remote control, refer to page 34 or 36.

Automatic* opening and closing

Briefly press the switch past the resistance point and then release it.

In addition, the following response is also automatic:

With the roof open, briefly press the switch in the Raise direction: the roof rises to its tilt-up end position.

Press the switch again in any direction to stop the roof.



The automatic opening feature in the Raise direction can be deactivated. Please contact your BMW center for assistance. ◀

Safety feature

If the glass roof encounters resistance

- ▷ when it is closing from the raised position
- ▷ when it is closing from a point roughly past the middle of its travel

the closing cycle is interrupted and the glass roof will open again slightly.



Despite this safety feature you should always inspect the roof's travel range prior to closing it, as the safety feature might fail to detect certain kinds of obstructions, such as very thin objects, and the roof would continue closing.

Pressing the switch beyond the resistance point and holding it limits the response of the safety feature. The roof only opens a short distance.

If you again press the switch past the resistance point and hold it in position within about 1.5 seconds, the safety feature will be deactivated. ◀



When you close the glass roof, it will slow down as it approaches the end of its travel path; this is to allow the safety feature to respond more precisely to any obstructions encountered in this critical range. ◀

Following interruptions in electrical power supply

Following interruptions in electrical power, for instance, when the battery is disconnected, it is possible that the glass roof will extend to its tilt-up position, but fail to respond to other commands. Should this occur, please have the roof reinitialized at your BMW center.

Malfunctions

In the event of an electrical malfunction, you can operate the glass roof manually:

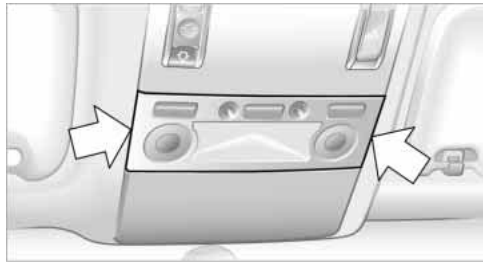

1. Take out the interior lamp, reach behind the opening, press out the cover

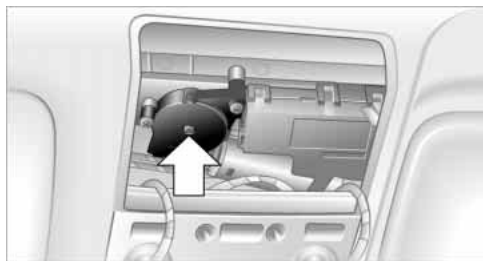

2. Insert the Allen wrench supplied with the onboard tool kit, refer to page 200, in the opening provided. Turn to slide the glass roof in the desired direction.

Adjustments

Sitting safely

The ideal sitting position can make a vital contribution to relaxed driving that is as fatigue-free as possible. The sitting position plays an important role together with the safety belts and airbags in an accident. To ensure that the safety systems operate with optimized efficiency, we strongly urge you to observe the instructions contained in the following section.

For additional information on transporting children safely, refer to page 56.

Sitting safely with airbags

 Always maintain an adequate distance between yourself and the airbags. Always hold the steering wheel by its rim with hands at the 9 o'clock and 3 o'clock positions, to minimize the risk of injuries to your hands and arms in the event of airbag deployment.

No one and nothing is to come between the airbags and the seat occupant.

Do not use the cover of the front airbag on the front passenger side as a storage area. Make sure that the front passenger is correctly seated and does not rest feet or legs on the instrument panel, otherwise leg injuries can occur if the knee and front airbag are triggered.

Never let an occupant's head rest near or on a side airbag because the inflating airbag could cause a serious or fatal injury. ◀

Even if you adhere to all the instructions, injuries resulting from contact with airbags cannot be fully excluded, depending on the circumstances. The ignition and inflation noise may provoke a mild – usually temporary – hearing loss in extremely sensitive individuals.

For airbag locations and additional information on airbags, refer to page 97.

Sitting safely with safety belts

Fasten your safety belt before starting any trip. Although airbags enhance safety by providing added protection, they are not a substitute for safety belts.

Your vehicle has five seats that are all equipped with a safety belt.

 At all times, occupants should sit upright and be properly restrained – infants and small children in appropriate child-restraint systems; larger children and adults using the safety belts.

Expectant mothers should always wear their safety belts, taking care to position the lap belt against the lower hips, where it will not exert pressure against the abdominal area.

Never allow more than one person to wear a single safety belt. Never allow infants or small children to ride in a passenger's lap. Do not route the belt across your neck, or run it across sharp edges. Be sure that the belt does not become caught or jammed. Avoid twisting the belt while routing it firmly across the hips and shoulder. Do not allow the belt to rest against hard or fragile objects. Otherwise, in the event of a frontal impact, a loose lap belt could slide over your hips, leading to abdominal injury. Avoid wearing clothing that prevents the belt from fitting properly and pull the lap belt periodically to readjust the tension across your shoulder in order to avoid a reduction in the retention effect of the safety belt. ◀

For instructions on operating safety belts, refer to page 49.

Seats

Note before adjusting

 Never attempt to adjust your seat while operating the vehicle. The seat could respond with unexpected move-

ment, and the ensuing loss of vehicle control could lead to an accident.

Also on the passenger's side, do not incline the backrest too far to the rear while the vehicle is being driven, as otherwise there is a danger in the event of an accident of sliding under the safety belt, eliminating the protection normally provided by the belt. ◀

Please observe the information on damage to safety belts provided on page 49 and the information on the active head restraints on page 47.

The concept



You adjust the seat in two stages:

- 1 Preselect the function: the button lights up brightly
- 2 Adjustments: slide control knob to
 - ▷ front or rear ◀▶ or
 - ▷ upwards or downwards ▲▼
 - ▷ or turn ▶◀

Electric power seat adjustment

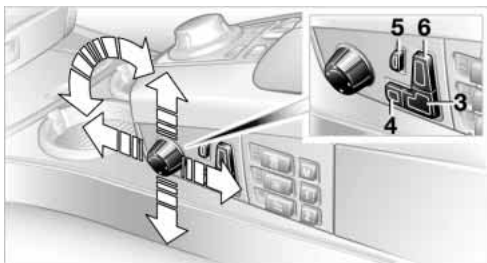

You can use the control knob to adjust various functions after first selecting them with the buttons.

 To ensure that the safety systems continue to provide optimized protection, please observe the adjustment instructions on page 44. ◀

- 3 Forward/backward: ◀▶
Height: ▲▼
Backrest: ▶◀
This button is always ready for operation
- 4 Thigh support: ◀▶
Height: ▲▼
Tilt angle: ▶◀
- 5 Lumbar support*, refer to page 46
- 6 Height of the head restraint: ▲▼

Front comfort seat* adjustment

In addition to the electric power seat functions, several other adjustment options are also available with the comfort seat:

- 4 Thigh support: ◀▶
Tilt angle: ▶◀
- 5 Lumbar support, refer to page 46
Backrest width:
Increase or decrease lateral support ▶◀
- 6 Shoulder support, refer to page 46
Height of the head restraint: ▲▼
Backrest: ▶◀

Automatic backrest width adjustment

The backrest automatically moves to the widest possible position to ease driver entry and exit before then returning to the standard position or stored memory setting.

This automatic system is influenced on both seats by each door as well as on the driver's seat by the ignition and on the front passenger's seat by the safety belt buckle.

Sports seat* adjustment

In addition to the electric power seat functions, several other adjustment options are also available with the sports seat:

- 4 Thigh support: ◀▶
- 6 Height of the head restraint: ▲▼

Lumbar support adjustment

5 Lumbar support

You can also adjust the contours of the backrest to obtain additional support in the lumbar region.

The upper hips and spinal column receive supplementary support to help you maintain a relaxed, upright sitting position.

- ◀▶ Increase or decrease curvature
- ▲▼ Increase curvature at top or bottom.

Shoulder support adjustment

6 Adjust the tilt angle of the shoulder support: ◀▶

You can use the adjustable upper backrest for supplementary support in the shoulder region. This provides a relaxed driving position and helps relieve stress on the shoulder muscles.

 Make corrections in the forward/backward adjustment of the seat to ensure that the safety belt still fits firmly against your body. If you do not do this, the protection provided by the safety belt may be reduced. ◀

Rear comfort seat* adjustment

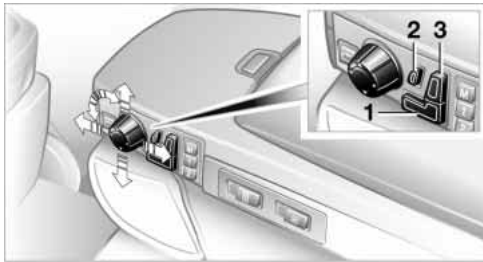

You can use the control knob to adjust various functions after first selecting them with the buttons.

- 1 Forward/backward: ◀▶
Tilt angle: ▲▼
Backrest: ▶◀
This button is normally active
- 2 Lumbar support, see above

- 3 Shoulder support: ◀▶
Height of the head restraint: ▲▼
Backrest: ▶◀

 It is not possible to adjust the comfort seats if the safety switch for the power windows has been pressed, refer to page 42. ◀

Adjusting passenger seat from the rear

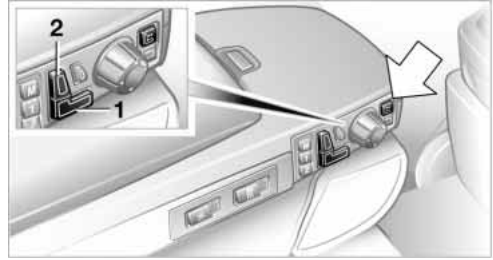

The front passenger's seat can be adjusted from the rear sitting positions, for instance, when a rear passenger desires more leg-room.

Press the button to activate this function, refer to arrow.

You can use the control knob to adjust the settings after selecting the desired function with the buttons.

- 1 Forward/backward: ◀▶
Height: ▲▼
Backrest: ▶◀
- 2 Height of the head restraint: ▲▼

Press the button again, refer to arrow, to deactivate this function.

Resetting to standard adjustment position

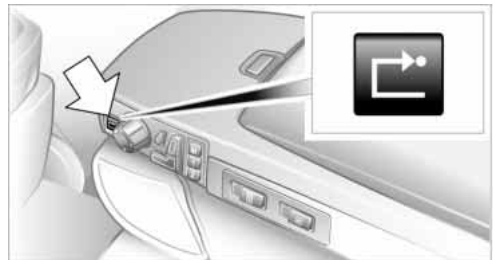

You can use the button to return the rear seats to their standard or default positions. Maintain pressure on the button until the system completes the adjustment.

 It will be necessary to return the rear seats to their standard position, for instance, before using a child-restraint system, refer to page 56. ◀

Head restraints

Adjustment information

 Head restraints reduce the risk of spinal injury in the event of an accident. Adjust the head restraints so that they are centered roughly at the level of your ears. ◀

Adjusting the height

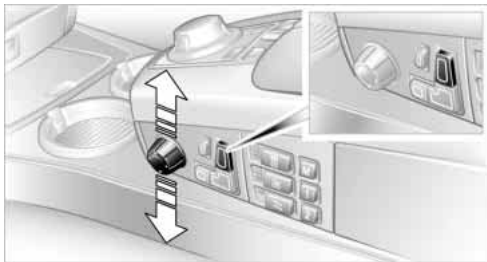

▲▼ Adjust the height of the head restraint.

Adjusting the tilt angle



Swivel the head restraint.

 With the comfort seat, adjust the distance to the back of the head via the shoulder support. ◀

Adjusting the side extensions



You can fold the side extensions on the head restraint forward for increased lateral support.

Front head restraints, active*

The front comfort seats are equipped with an active head restraint.

When necessary, the system will respond to a rear impact by automatically triggering the active head restraints.

 To ensure that the active head restraints afford maximum protection, and to avoid unnecessary risks to personal safety, we request that you read and comply with the following.

- ▷ Adjust the head restraints so that they are centered at roughly ear height
- ▷ Do not install seat or head-restraint covers
- ▷ Never use the head restraints as supports for suspending objects of any kind, such as clothes hangers. Refrain from mounting accessories on either the seat or the head restraint. ◀

Rear seats

Adjusting manually

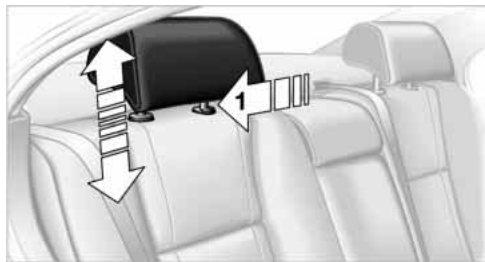

- ▷ To raise: pull
- ▷ To lower: press the button, arrow 1, and push down the head restraint.

To remove head restraints, refer to next column.

Center head restraint adjustment

 If the head restraint has been lowered, pull it back up, continuing until the detent engages, before allowing a passenger to ride in the rear center position. Otherwise the level of occupant protection can be reduced. ◀

Adjusting electrically*

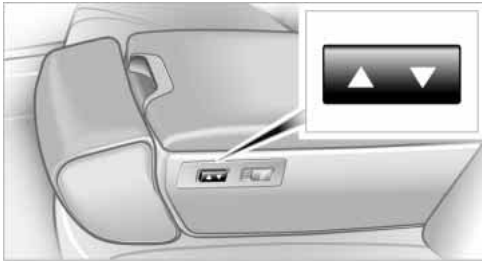

If necessary, adjust the head restraint's height to ensure that it is centered at roughly the height of the passenger's ears.

 With the safety switch pressed, refer to page 42, the height adjustment of the head restraints is deactivated. ◀

The head restraints at the outer sitting positions extend automatically whenever the system detects a passenger on the seat. You can also adjust the height of the head restraint electrically.

 To prevent possible personal injury and property damage, always ensure that the area above the head restraints is clear and unobstructed before extending them upward. ◀

Manual head restraint removal and installation

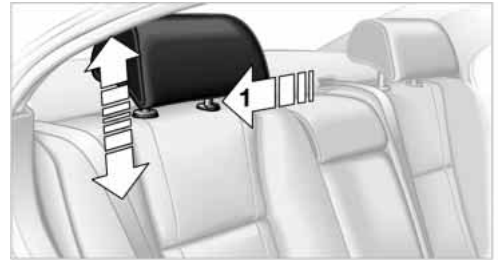

Removal

1. Pull the head restraint upward to the stop
2. Press the button, arrow 1, and remove the head restraint.

Installation

1. Press the button, arrow 1, and slide the head restraint into its support
2. Adjust the head restraint for your personal comfort.

Rear comfort seat*

Adjusting the height

If necessary, adjust the head restraint's height to ensure that it is centered at roughly the height of the passenger's ears.

 With the safety switch pressed, refer to page 42, the height adjustment of the head restraints is deactivated. ◀

The head restraints at the outer sitting positions extend automatically whenever the system detects a passenger on the seat. You can also adjust the height of the head restraint electrically.

 To prevent possible personal injury and property damage, always ensure that the area above the head restraints is clear and unobstructed before extending them upward. ◀

Adjusting the side extensions



You can fold the side extensions on the head restraint forward to increase lateral support.

Safety belts



Fastening

Make sure you hear the latch plate engage in the belt buckle.



The warning lamp in the instrument cluster lights up for a few seconds or until the belt has been fastened.

Depending on the model, a signal * sounds simultaneously or a message* appears in the Check Control.

Releasing

1. Press the red button in the belt buckle
2. Hold the belt firmly
3. Guide the belt back into its reel.

The shoulder strap's anchorage point will be in the correct position for seat occupants of every build if the seat is correctly adjusted, refer to page 44.

The two rear safety belt buckles integrated in the rear seat are for passengers sitting on the left and right. The belt buckle embossed with the word CENTER is intended exclusively for use by passengers riding in the center position.

Damage to safety belts

 If the safety belts are damaged or stretched in an accident: have the entire belt system, including the tensioning mechanisms, replaced at your BMW center. Have the belt anchorage points inspected for damage at the same time. Failure to observe this precaution may prevent the safety belts from effectively providing optimal protection when needed. ◀

Rear seats

 When the rear center position is not occupied, the latch on the safety belt can be inserted in the slot between the seat's upholstery and the backrest. ◀

Seat heating*

Front



The system regulates the temperatures of the seat cushion and backrest.

The temperature setting progresses one step through its control sequence each time you press the button.

To switch off:

Maintain pressure on the button for several seconds.

Rear



The operating concept is the same as for the front heated seats.

Temperature distribution at the front

It is possible to select a temperature-distribution pattern providing different levels of heating for the seat cushion and the backrest, for instance, to adapt for different clothing on the legs and upper body.

1. Select "Climate"
2. Select  and confirm

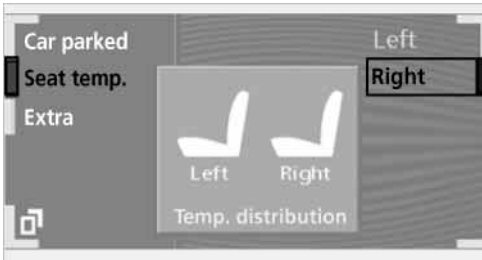

3. Select "Seat temp." and confirm
4. Select "Left" or "Right" and confirm
5. Turn to adjust temperature distribution
6. Press to confirm your entry.



The system automatically selects your individual temperature distribution settings each time you unlock the vehicle using your personal remote control unit. ◀

Active seat ventilation*



Front

The system progresses one step through the control sequence each time you press the button.

To switch off:

Maintain pressure on the button for several seconds.



Use level 3 to cool the passenger compartment rapidly, for instance, when heat accumulates in the vehicle. The system automatically reverts to operation at level 2 after a brief period. ◀

Rear



The operating concept is the same as for the front seat ventilation.

Active seat*



Active adjustment of the seat cushion's contours reduces muscular tension and fatigue to help prevent lower back pain.

To activate: press the button, the indicator lamp comes on.

Mirrors

Adjusting exterior mirrors



- 1 4-way adjustment
- 2 To select mirror for adjustment

! To prevent the exterior mirrors on this vehicle from being damaged, always fold them in by hand before entering an automatic car wash. ◀

You can also adjust the mirrors manually by pressing against the outer edges of their lenses.

Storing the mirror positions, refer to Seat, mirror and steering wheel memory on page 53.

! The mirror on the passenger's side features a lens with a more convex surface than the mirror installed on the driver's side. When estimating the distance between yourself and other traffic, bear in mind that the objects reflected in the mirror are closer than they appear. This means that estimations of the distance to following traffic should not be regarded as precise. ◀

Self-defrosting mirrors

The mirrors are automatically heated whenever the ignition is switched on.

Interior and exterior mirrors, automatic dimming feature*

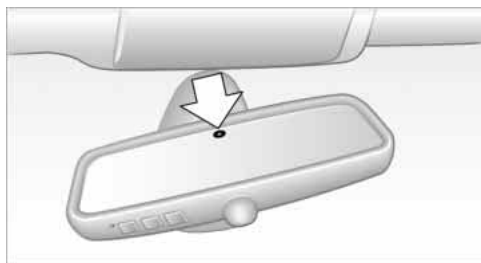

These mirrors automatically respond to ambient light and headlamp glare from following vehicles by automatically dimming through an infinitely-variable range. There are two photocells located in the interior rearview mirror for this purpose. One is integrated within the mirror's lens, arrow, while the other is located at an offset position on the rear of the mirror housing.

The mirrors automatically revert to their clear, undimmed mode whenever you place the selector lever into reverse.

▷ For trouble-free operation, keep the photocells clean and do not cover the area between the interior rearview mirror and the windshield. Do not attach any kind of stickers on the windshield in front of the mirror, either. ◀

Illuminated vanity mirror in the rear

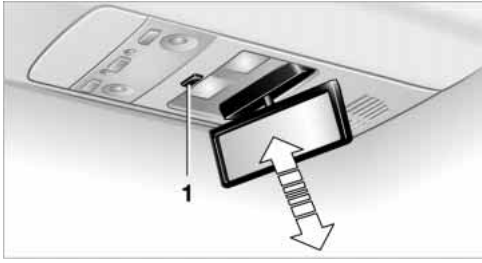

1. Press button 1. The vanity mirror folds down
2. Pull the mirror slightly downwards before you swivel it
3. Press the vanity mirror back up before folding it back in.

Steering wheel adjustment



The steering wheel can be adjusted in any of four directions by pressing the appropriate end of the button.

⚠ Do not adjust the steering wheel while the vehicle is moving. There is a risk of accident from unexpected movement. ◀

Storing steering wheel positions, refer to Seat, mirror and steering wheel memory on page 53.

Automatic steering wheel adjustment

The steering wheel automatically moves as high up and far forward as possible to ease driver entry and exit before then returning to the standard position or stored memory setting.

This automatic feature is governed by the driver's door and the ignition switch.

Steering wheel heater*

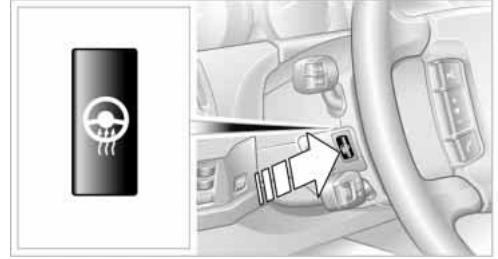

The steering wheel heater operates when the ignition is on.

Press the button to activate or deactivate this system.

The indicator lamp within the button lights up when the steering wheel heater is in operation.

Programming button function



You can assign specific individual functions to the programmable button. This feature then provides you with quick access to this function, allowing you to control it without undue distraction from road and traffic conditions.

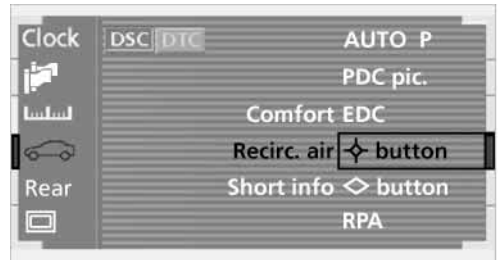

1. Select "Settings"
2. Confirm
3. Select "❖ button". Continue to press the controller until the desired function appears:

▷ "Recirc. air"

In this mode the supply of outside air remains blocked, refer to AUC Auto-

matic recirculated-air control on page 104

▷ "Navi info"

To repeat the most recent message from the navigation system, refer to page 141

▷ "AUTO P"

To activate/deactivate Automatic Hold refer to Automatic Hold on page 63.

You can select the displayed function using the button on the steering wheel.



If you have activated Automatic Hold, refer to page 63, you can use the button on the steering wheel to deactivate the system for parking maneuvers etc. ◀

Seat, mirror and steering wheel memory

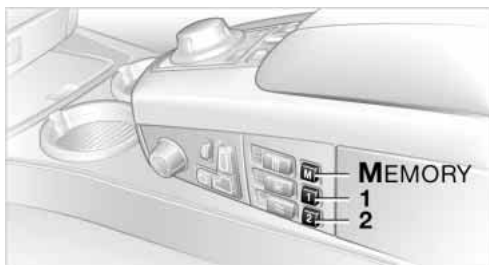

You can store and select two different adjustment settings for the driver's seat, exterior mirrors and steering wheel.

If your vehicle is equipped with comfort seats, you can also store and set two sitting positions for each additional seat with the memory.

The adjustment of the lumbar support is not stored in the memory.

Storing

1. Radio mode, or switch on ignition
2. Set desired sitting position; for driver's seat as well as the exterior mirror and steering wheel position

3. Press **MEMORY** button:
The indicator lamp within the button comes on
4. Press the desired memory button **1** or **2**:
The indicator lamp goes out.

Selecting a stored setting

Convenience mode

1. Driver's door open after unlocking or ignition lock in radio position
2. Briefly press the desired memory button **1** or **2**.

The system immediately cancels the adjustment procedure when you press one of the seat adjustment buttons or use one of the memory buttons.

Safety feature

1. Driver's door closed and ignition switched either on or off
2. Press memory button **1** or **2** and maintain pressure until the adjustment process has been completed.

If you press the **MEMORY** button accidentally:

Press the button again; the indicator lamp goes out.



Do not call up a position from the memory while the vehicle is moving. There is a risk of accident from unexpected movement of the seat or steering wheel. ◀



You can have your vehicle programmed to automatically dial in your own individual adjustment settings for the seat, mirrors and steering wheel whenever you use your personal remote control unit to unlock the vehicle. ◀



When using the Key Memory feature always make sure that the footwell behind the driver's seat is empty and unobstructed. If you fail to do so, any persons or objects behind the seat could be injured or damaged by a rearward movement of the seat. ◀

Tilt function, passenger-side mirror

Automatic curb monitor

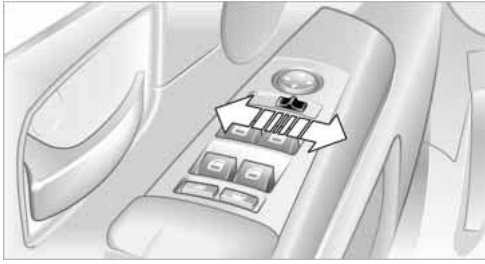

1. Select the driver's door mirror with the switch
2. When you select the transmission position R, the door mirror on the front passenger side tilts downward slightly. This allows the driver to see the area immediately adjacent to the vehicle – such as a curb – when parking, etc.

You can deactivate this automatic feature: Slide the mirror selection switch to the passenger's side position.

Vehicle Memory, Key Memory

How the system functions

Doubtless you have often reflected on how great it would be if you could configure your vehicle's various adjustment settings to meet your own personal requirements. In developing your vehicle, BMW has incorporated a number of options for personal adjustment which you can set with the Control Center. You can also have these programmed at your BMW center.

There are vehicle-related and person-related adjustments: Vehicle Memory and Key Memory. You can have up to four different basic settings adjusted for four different persons. The only requirement is that each person uses his or her own remote control.

When your vehicle is unlocked with the remote control, the vehicle recognizes the individual user by means of a data

exchange with the key, and makes adjustments accordingly.

To differentiate

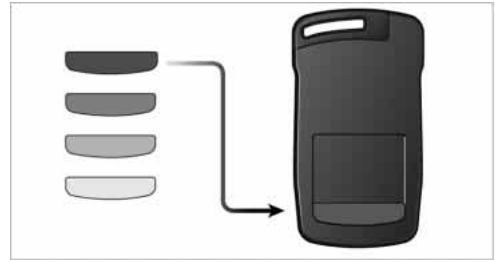

Color-coded decals are provided to help you distinguish the individual remote control units with their different settings.

What the system can do

Please contact your BMW center for more information on the range of options available with Vehicle Memory and Key Memory.



You will see this symbol throughout the Owner's Manual. It is to remind you at appropriate places of the settings that are available to you. These positions can be looked up in the index under the respective keyword. ◀



Following configuration of the memory functions, vehicle operation may differ from the description in the Owner's Manual. Should you want to sell your BMW some day, please remember to have the memory functions reset to the default state. ◀

Examples of Vehicle Memory functions

- ▷ Central locking system: set different signals as an acknowledgment
- ▷ Pathway lighting: activate/deactivate function
- ▷ Daytime driving lamps: activate/deactivate function
- ▷ Alarm system: set different acknowledgment signals to confirm arming/disarming

- ▷ Alarm system: activate/deactivate interior motion sensor and tilt alarm sensor
- ▷ Automatic headlamp control: adjust sensitivity.

Examples of Key Memory functions

- ▷ Seat memory: activate/deactivate function
- ▷ Central locking system: vehicle is locked as soon as you drive off or if you have not opened a door or the luggage compartment lid after unlocking. Activate/deactivate functions
- ▷ Automatic climate control: key-specific storage of the temperature, blower and air conditioner setting. Activate/deactivate function
- ▷ Check Control: set languages and units
- ▷ Seat heating: recall personal temperature distribution.

Transporting children safely

The right place for children

Children always in the rear

Accident research shows that the safest place for children in a vehicle is in the rear seat.

Older children should be tightly secured with a safety belt, after they have outgrown a booster seat that is appropriate for their age, height and weight.

 A child sitting in the rear seat and not properly restrained may place his or her head on or near the airbag, if so equipped. For example, a child – even though belted – may fall asleep with his or her head against the side airbag. It may be difficult for a driver to ensure that children in the rear seat will remain properly positioned at all times and do not place their heads on or near the side airbags. Therefore, we recommend that the rear side airbags, if provided, be deactivated if you plan to transport children in the rear seat. ◀

Child-restraint system in the rear

Child-restraint systems appropriate for every age group and weight are available at your BMW center.

 Children under 13 years of age and children less than 5 ft/150 cm tall should always ride in the rear and the restraint systems should be secured with the vehicle's safety belts. ◀

Younger children should be secured in an appropriate forward-facing child-restraint system that has first been properly secured with a safety belt.

All rear sitting positions in your vehicle meet the recommendations of SAE J1819, an industry-recommended practice for securing child-restraint systems in motor vehicles.

Exception for the front passenger seat

 Should it become necessary to use a child-restraint system on the front passenger seat, the airbags on the passenger's side must be deactivated. Your BMW center will be glad to advise you. ◀

 Never install a rearward-facing child-restraint system in the front passenger seat of this vehicle if the passenger airbag is not deactivated. If you do so, the child could be severely injured when the airbag is triggered.

Your vehicle is equipped with an airbag supplemental restraint system for the front passenger. Because the backrest on any rearward-facing child-restraint system – of the kind designed for infants under 1 year and 20 lbs./9 kg – would be within the airbag's deployment range, you should never mount such a system in the front passenger seat, since the impact of the airbag against the child restraint's backrest could lead to serious or fatal injuries. ◀

Installing child-restraint systems

Before installing any child-restraint system or child seat, read the following:

 Observe the child-restraint system manufacturer's instructions for installation and use. Otherwise the degree of protection can be reduced.

After an accident, have all parts of the child-restraint system and of the relevant vehicle safety belt system checked by a BMW center and replaced if necessary. ◀

Commercially-available child-restraint systems are designed to be secured with a lap belt or with the lap belt portion of a combination lap/shoulder belt. Improperly or inadequately installed restraint systems can increase the risk of injury to children.

Always read and follow the instructions that come with the system.

Child seat security



All of the rear belt retractors and the front passenger's safety belt can be locked for mounting and securing child-restraint systems.

Information regarding this is located near the buckle latch of each safety belt.

To lock the safety belt

Pull the entire length of the belt from the belt retractor. Allow the reel to retract the belt somewhat and engage the buckle, then tighten the belt against the child-restraint system. The retraction mechanism is now locked.

To unlock the safety belt

Release the buckle, remove the child-restraint system and allow the belt retractor to reel the belt completely in.

Child-restraint system with tether strap

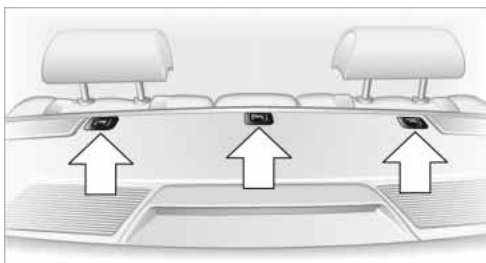

If you use a child-restraint system with a tether strap, three additional tether anchor points have been provided, refer to the

arrows in the illustration. Depending on the location selected for sitting in the rear passenger area, attach the tether strap to the corresponding anchorage point to secure the child-restraint system, as shown in the illustration below.

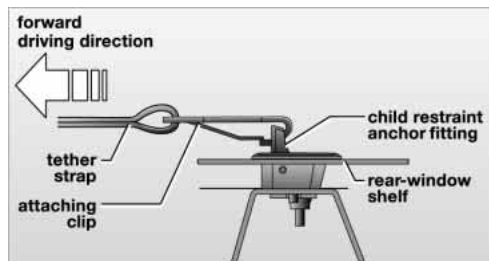

Each sitting position is fitted with a head restraint.

Outer sitting positions:

Lift the head restraint and pass the tether strap between the head restraint and the seat back. It is recommended to readjust the head restraint into the lowest possible position.

Center sitting position:

The head restraint must be adjusted into the lowest possible position. Pass the tether strap over the head restraint.

▶ Adjust the tether strap according to the child-restraint manufacturer's instructions. ◀

LATCH* child-restraint fixing

LATCH: Lower Anchor and Tethers for Children.

The rear outer sitting positions are provided with anchors for a LATCH child-restraint fixing.

⚠ To fit the LATCH child-restraint fixing, follow the operating and safety instructions of the manufacturer. ◀

If the vehicle is equipped with electric power seats in the rear, return these to their standard adjustment setting before using a LATCH child-restraint fixing, refer to page 46.

Access to anchorage points

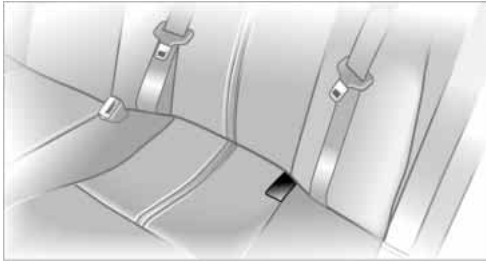

The illustrations show the left rear seat as an example. The outer anchorage points for the LATCH child-restraint fixing are identified by small flags.

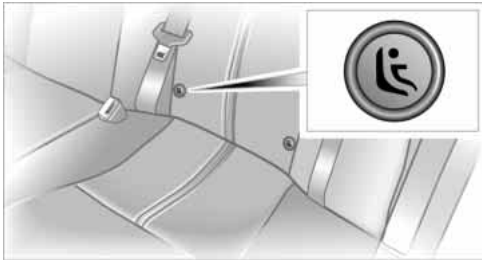

Canadian models only:
The anchorage points for the LATCH child-restraint fixing are identified by buttons.

Installation guide

The installation guide makes it easier to fit the LATCH child-restraint fixing and at the same time protects the surface of the seats.

 The installation guide is available at your BMW center. Always observe all instructions for installation and use provided by the child-restraint's manufacturer. ◀

1. Engage the center safety belt into the belt buckle
2. Pull the belt away from the area of the child-restraint fixing



3. Firmly press the installation guide into the gap between the upholstery on seat and backrest, continuing until the two funnel-shaped guides snap into place in the LATCH support braces in the seat. Pull the installation guides to remove.

On journeys

 Make sure that children do not lean out of the child's seat towards the door panels. Otherwise severe injuries can be caused if the side airbags are triggered. ◀

Child safety locks for the rear doors



Slide down the safety levers on the rear doors:

The relevant door can now be opened from the outside only.

Safety switch for power windows and rear seats

If the vehicle is equipped with electric power seats in the rear, return these to their standard adjustment setting before using a child-restraint system, refer to page 46.

Always press the safety switch for the electric power windows, refer to page 42, when children are in the rear of the vehicle. This switch also disables the power rear seat adjustment.



Incorrect or unsupervised adjustment of the electric power seats in the rear could lead to injuries or damage to the child-restraint system. ◀

Driving

Ignition lock



Insert the remote control all the way into the ignition lock. This also activates the radio mode.

▶ When the remote control unit is in the ignition lock you can start the engine without first switching on the ignition. ◀

Comfort Access*

Carry the remote control on your person if you want to use Comfort Access.

With Comfort Access, you do not need to insert the remote control in the ignition lock. You can switch the ignition on and off, see below, or start the engine, page 61, when a remote control is detected in the vehicle interior.

▶ When you switch off the engine, the transmission moves automatically to position P: interlock. ◀

Switching the ignition on and off



Continue to briefly press the start/stop button to switch the radio mode on and off or switch the ignition on and off.

▶ Do not press the brake pedal until you are ready to start the engine. If you briefly press the start/stop button while the brake pedal is pressed the engine will start immediately. ◀

Radio mode

Several systems, such as the Control Center, independent ventilation, etc., are available for use. The time and outside temperature appear in the Info Display.

▶ The radio mode is automatically deactivated:

- ▶ After approx. 16 minutes, when a door is closed and the system does not register the presence of any individuals in the vehicle
- ▶ Immediately if the remote control is removed from the ignition lock
- ▶ With Comfort Access, by pressing the door handle. ◀

Ignition switched on

All vehicle systems are ready for operation.

Ignition switched off

The indicator lamps in the Info Display go out. Only the automatic transmission's range display remains visible for a brief period.

Removing the remote control from the ignition lock

Press the remote control in briefly; it is ejected and now protrudes slightly from the lock. This procedure will also switch off the ignition if it is on.

▶ Switch off the engine before removing the remote control unit from the ignition lock.

The transmission automatically shifts to position P: interlock. ◀

If the remote control is still in the ignition lock when the driver's door is opened, a gong will sound and a message will appear in the Info Display.

Starting the engine

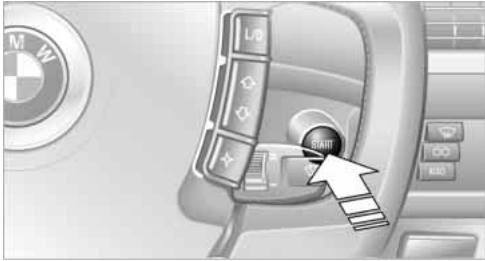

! Do not run the engine in closed rooms, as otherwise the inhaling of toxic exhaust gases can cause unconsciousness and death. The exhaust gases contain carbon monoxide, an odorless and colorless, but highly toxic gas. Never leave an unattended vehicle with the engine running, as such a vehicle represents a potential safety hazard. ◀

1. Insert the remote control all the way into the ignition lock. With Comfort Access, this is not required
2. Press the brake pedal
3. Briefly press the start/stop button.

▷ Your BMW is equipped with the convenience starting feature. After pressing the brake pedal, all you need to do is briefly press the start/stop button.

The system responds by automatically engaging the starter and allowing it to run until the engine starts, after which it then disengages automatically.

The automatic starting mode will not operate or will be canceled if the battery voltage is low. The engine can be started by jump-starting, refer to page 207. ◀

Do not allow the engine to warm up by leaving it running while the vehicle remains

stationary. Instead, drive off immediately at a moderate engine speed.

▷ If you have accidentally switched off the engine while driving, it can be restarted from a speed of approx. 3 mph/ 5 km/h by pressing the button. It is not necessary to press the brake pedal. ◀

Under the following conditions you should press the accelerator pedal halfway down when starting:

- ▷ If the engine fails to start on the first attempt, for instance, if it is very hot or cold
- ▷ During a cold start at high altitudes, from approx. 3,281 ft/1,000 m, at very low temperatures, from approx. + 5 °F / - 15 °C.

! Refrain from starting the vehicle repeatedly at brief intervals, and avoid an excessive number of starting attempts if the vehicle fails to start; repeated activation of the starter over an extended period would allow unburned or only partially combusted fuel to enter the catalytic converter, where it can cause overheating and damage to the unit. ◀

Switching off the engine

With the vehicle stationary, briefly press the start/stop button. This also activates the radio mode.

The transmission automatically shifts to position P: interlock.

▷ Transmission position N remains engaged if you keep to the following order:

1. With Comfort Access: insert the remote control into the ignition lock
2. With the engine running, engage transmission position N
3. Switch off the engine
4. Leave the remote control in the ignition lock.

This function is useful in automatic car washes, etc.

Position P is engaged automatically after

approx. 30 minutes or when you remove the remote control from the ignition lock. Remember to observe the Check Control for status messages. ◀

▶ Should exceptional circumstances render it necessary for you to switch off the engine while the vehicle is moving, press the start/stop button for approx. 1 second.

If you maintain pressure on the start/stop button for longer than two seconds while switching off the ignition, the remote control will be ejected. ◀

⚠ Before leaving the vehicle, remove the remote control from the ignition lock; with Comfort Access, always take the remote control with you. ◀

Parking brake

The concept

Your BMW is equipped with an electromechanical parking brake.

The parking brake is primarily intended to prevent the vehicle from rolling while parked.

You can operate or use the parking brake in two different ways:

- ▷ Manually, by briefly pressing the button
- ▷ Automatically, through activation of the Automatic Hold mode, refer to page 63.

An electrohydraulic mechanism then engages the parking brake to prevent the rear wheels from turning whenever you switch off the engine.

When the engine is running, parking brake engagement is controlled by the brake system's hydraulic circuits, which act on the disc brakes at the front and rear wheels.

Brake pedal feel

Because this function is activated using the brake system's hydraulic circuits, the response of the brake pedal may change slightly. Engagement may also be accompanied by activation noise – this is normal.

Manual engagement



Ⓟ Briefly press the button, the word PARK appears briefly in the Info Display. With the parking brake set, the indicator lamp Ⓟ lights up red in the

Info Display, refer to page 12.

▶ With the ignition off, the indicator lamp Ⓟ goes out after a brief period. ◀

Manual release

Ⓟ With the ignition on, briefly press the button: the indicator lamp in the Info Display goes out.

▶ Provided that the remote control unit is inserted in the ignition lock, you can also release the parking brake after the engine has been switched off. This function is intended for use in automatic car washes, etc. ◀

⚠ When leaving the vehicle, always release the remote control from the detent in the ignition lock; this precaution prevents children from disengaging the parking brake, etc.

The parking brake can still be engaged at any time when the remote control unit is released from the detent. It is only possible to disengage the parking brake with the ignition on. ◀

⚠ If exceptional circumstances should make it necessary to engage the parking brake while the vehicle is in motion, maintain pressure on the button. The indicator lamp appears in red in the Info Display. A gong sounds at the same

time.

The brake lamps come on.

The vehicle continues to brake automatically for as long as you maintain pressure on the button. ◀

 When you brake the vehicle to a virtual stop, i.e., down to a speed of approx. 2 mph/3 km/h or below, the parking brake remains engaged. The indicator lamp (P) in the Info Display lights up red. Briefly press the button to disengage the parking brake manually. ◀

Automatic Hold

You can activate this feature after starting the engine; it then remains operational until the next time the engine is switched off.

This feature provides supplementary support during vehicle operation by automatically engaging and releasing the parking brake during stops at traffic lights, in stop-and-go traffic, etc. As the vehicle then no longer tends to creep when the transmission is engaged, it is no longer necessary to hold the vehicle by pressing the brake pedal.

It prevents the vehicle from rolling backward during uphill starts.

The parking brake engages automatically when you stop the vehicle and switch off the engine.

You can activate or cancel the Automatic Hold feature by selecting the "Settings" menu in the Control Center. A description of the Control Center is provided on page 17.

Automatic Hold activation/deactivation



1. Select "Settings"
2. Select  and confirm
3. Select "AUTO P". Press the controller to activate/deactivate the desired function

- ▷ Automatic Hold is activated. The green AUTO P status message in the Info Display shows you that the system is ready for operation
- ▷ Automatic Hold is deactivated. The green AUTO P status message disappears from the Info Display.

 You can assign the Automatic Hold function to the programmable button in the steering wheel, refer to page 52. This feature then provides you with quick access to the Automatic Hold function, allowing you to control it without undue distraction from road and traffic conditions. ◀

 You can also deactivate Automatic Hold by pressing the button while the vehicle is stationary. The vehicle remains stationary, the indicator lamp changes from green to red. Press the button again to release the parking brake.

Driving with Automatic Hold

The parking brake engages automatically when the vehicle comes to a stop. The indicator lamp (P) in the Info Display lights up green.

To start off again, simply press the accelerator pedal. The parking brake is released automatically; the indicator lamp (P) goes out.

 Do not drive through an automatic car wash with the Automatic Hold on and the engine running. The system would engage the parking brake while the vehicle is stationary. ◀

Parking with Automatic Hold

The parking brake engages automatically when you stop the vehicle and switch off the engine. The indicator lamp (P) changes from green to red.

 Provided that the remote control is inserted in the ignition lock, you can also release the parking brake manually after the engine has been switched off, refer to page 62. This function is useful in automatic car washes, etc. Automatic Hold is deactivated. ◀

 When leaving the vehicle, always release the remote control from the detent in the ignition lock; this precaution prevents children from disengaging the parking brake, etc. ◀

For your safety

Automatic Hold is automatically deactivated when

- ▷ the engine is switched off
- ▷ the system detects that the driver's seat is not occupied while the engine is running
- ▷ the hood is opened while the engine is running
- ▷ the luggage compartment lid is opened with the transmission in reverse while the engine is running, and
- ▷ when the parking brake is used to bring the vehicle to a stop.

The indicator lamp  changes from green to red, and the AUTO P letters in the Info Display disappear.

Before starting off again, briefly press the button to disengage the parking brake manually, refer to page 62, or reactivate Automatic Hold, refer to page 63.

 Before leaving the vehicle with the engine running, always move the automatic transmission's selector lever to position P and ensure that the parking brake is engaged. The vehicle could start to roll if you fail to observe these precautions.

Never leave an unattended vehicle with the engine running, as such a vehicle represents a potential safety hazard. ◀

 Automatic Hold is automatically deactivated whenever the system detects any tendency for the wheels to spin in response to slippery road surfaces. Note

the status reports in the Check Control. You can find additional information on the Check Control on page 82. ◀

Malfunctions

If a malfunction occurs, the indicator lamp  lights up yellow in the Info Display and a status report will appear in the Check Control. Please note any supplementary information that appears on the Control Display.

Releasing the parking brake manually

You can respond to any interruptions in the supply of electrical power, for instance, if the battery is discharged or disconnected, by releasing the parking brake manually.

 Before proceeding to release the parking brake manually, and each time you park the vehicle without engaging the parking brake, always ensure that the automatic transmission's selector lever is in position P, refer to page 66. Note the range indicated in the Info Display. If the wheel must be changed on a surface with a more severe slope, take additional precautions to secure the vehicle from rolling e.g. with a chock, refer to page 203. Otherwise there is a danger that the vehicle could start to roll if parked on a steep slope. ◀

Should it also be necessary to release the automatic transmission's lockout manually, for instance, if the battery is discharged, always adhere to the following sequence:

1. If necessary, start by manually releasing the parking brake
2. Then release the automatic transmission's lockout manually, refer to page 68.

Jump-starting and towing, refer to pages 207 and 208.

What you will need

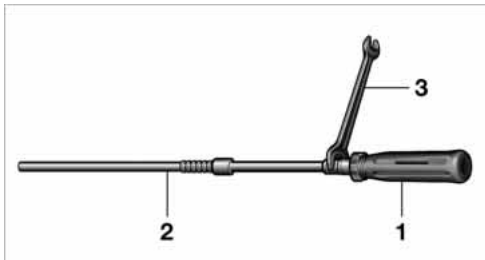

- 1 Screwdriver handle
- 2 Emergency-release tool
- 3 0.4 in/10 mm open-end wrench

You will find the required tools in the onboard tool kit mounted on the inside of the luggage compartment lid, refer to page 200.

Insert the emergency-release tool in the screwdriver handle as shown in the illustration.

Releasing



1. Remove the floor mat and the cover on the spare tire
2. Guide the emergency-release tool with the screwdriver handle into the opening, arrow 1
3. Apply the open-end wrench to the hexagon on the emergency-release tool.

Press against the resistance from the spring to guide the emergency-release tool all the way in, then hold it in place. Turn the emergency-release tool in the direction indicated by arrow 2, continuing until you hear the mechanism snap into place and feel resistance; maintain

pressure on the tool after the mechanism engages

4. Use the open-end wrench to turn the emergency-release tool against the drive unit's mechanical resistance, continuing to rotate it in arrow direction 2 until you feel a substantial increase in turning effort

 To prevent possible damage to the rear brakes, always make sure that the parking brake is completely released before driving the vehicle. ◀

5. Return the tools to their places
6. Return the spare tire cover and the floor mat to their original locations.

 Have any defects repaired at the nearest BMW center. The technicians can also return the parking brake to normal operational status after it has been released manually in response to malfunction. ◀

 Following manual release, the actual status of the parking brake may vary from that displayed by the indicator lamp. ◀

Operation after interruptions in power supply

 The parking brake may only be used again, if it was released manually after an interruption in power supply, i.e. as a result of a discharged or disconnected battery. If this is not done, the parking brake may fail to operate correctly. Even with the parking brake engaged, there would be a danger of the vehicle rolling on steep hills. ◀

Once the electrical power supply has been restored you can again use the parking brake:

 With the ignition on and the vehicle stationary, briefly press the button three times at intervals of approx. 5 seconds. This initializes the system as follows:

- ▷ Initializing the disengaged setting
- ▷ Engaging: the system registers the new status and the brake setting is initial-

ized. The indicator lamp (P) in the Info Display lights up red

- ▷ Releasing: the parking brake is ready for operation. The indicator lamp (P) in the Info Display goes out.

Automatic transmission with Steptronic

While you can drive as with any conventional automatic transmission, you also enjoy the option of shifting manually at the steering wheel, refer to page 67.

Transmission range selection



P R N D

Program display

S or M1 – M6

Buttons on the steering wheel



Press briefly to proceed through a selection sequence consisting of the automatic program, the sport program, and the manual mode.

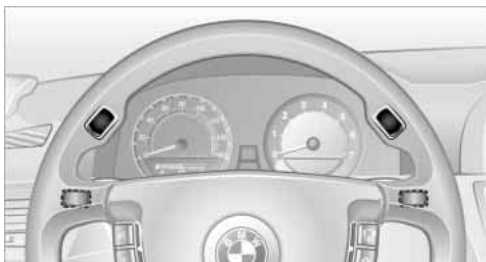

Steptronic:

Upshifting and downshifting, refer to Sport program and manual operation.

Selecting transmission range

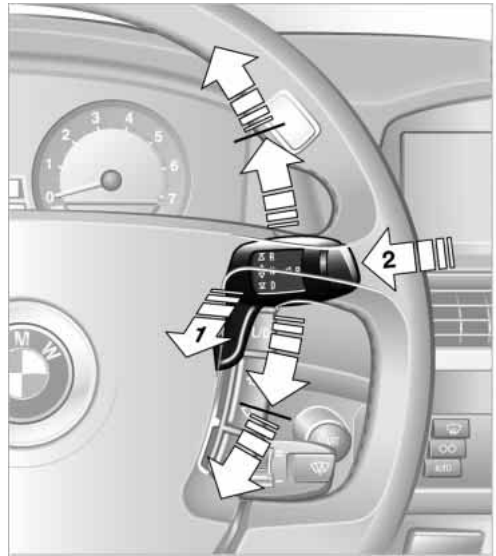

▷ The selector lever is at the center position. To select transmission ranges D, R or N, always start by pulling toward the steering wheel, arrow 1, then press up or down. Note the information provided in the Info Display. ◀

- ▷ Range D or R: Press the selector lever up or down, continuing to apply pressure to move it past the resistance point
- ▷ Neutral N: Press the selector lever as far as the resistance point
- ▷ Park P: Press button P, arrow 2.

The selector lever immediately returns to the center position when released.

▷ With the vehicle stationary, press the brake pedal before shifting out of P or N; the shift command will not be executed unless the brake is applied: shiftlock. To prevent the vehicle from creeping after you select a range, maintain pressure on

the brake pedal until you are ready to start. You can activate the Automatic Hold feature to suppress the vehicle's tendency to creep, refer to page 63. ◀

Shift commands are transmitted electronically. To help avoid malfunctions, each command undergoes a plausibility check prior to execution.

Remember to observe the Check Control for status messages.

You can find additional information on the Check Control on page 82.

 To prevent the vehicle from rolling, always select position P and engage the parking brake before leaving the vehicle with the engine running. Note the information provided in the Info Display. Never leave an unattended vehicle with the engine running, as such a vehicle represents a potential safety hazard. ◀

P Park

Select P only when the vehicle is stationary. The transmission lockout prevents the rear wheels from turning. The lockout disengages when you press the selector lever toward D, N or R while the engine is running.

 P is engaged automatically as soon as you switch off the engine unless N is engaged and the remote control is inserted in the ignition lock, refer to page 61. ◀

R Reverse

Select R only when the vehicle is stationary.

N Neutral

Select N only if your journey is interrupted for a long period.

- ▷ From D press the selector lever up
- ▷ From R press the selector lever down.

Note the arrows indicating direction in the range display.

 N remains engaged whenever the remote control unit remains in the ignition lock after the ignition is switched off. This function is useful in automatic car

washes, etc.

After approx. 30 minutes the system automatically engages P. Remember to observe the Check Control for status messages.

Switching off the engine, refer to page 61. ◀

D Drive, automatic driving position

This is the range recommended for normal vehicle operation. All forward gears are available.

Under normal operating conditions, fuel consumption is lowest when driving in position D.

Kickdown

The kickdown mode provides maximum acceleration.

Press the accelerator pedal beyond the full-throttle resistance point.

Sport program and manual operation



When you press the S/M/D button on the steering wheel once, the system responds by activating the transmission's Sport program, as indicated by the letter S in the program display of the Info Display, refer to

page 66. We recommend this program for performance-oriented driving.

When you press the S/M/D button a second time the transmission switches to its manual mode; press again to return to the automatic program.

You can also return to the standard automatic program by reselecting D.

In the manual mode the transmission upshifts when you briefly press the buttons on the rear of the steering wheel. You downshift by briefly pressing the buttons on the front of the steering wheel. The Info Display shows the manual ranges M1 through M6.

Upshifts and downshifts are executed only when they will result in a plausible combination of engine and vehicle speed; thus, for example, a downshift that would cause the engine to overrev will not be executed by the system. The selected gear appears briefly in the Info Display, followed by the current gear.

 To obtain maximum acceleration, for passing maneuvers, etc., during operation in the manual mode, use the kickdown or downshift manually. ◀

Malfunctions

A status report will appear in the Check Control to alert you to any malfunctions in the transmission-control system. Please note any supplementary information that appears on the Control Display. The directional arrows also start to flash in the Info Display.

While it will remain still possible to move the selector lever to any desired position, the transmission will revert to operation in its default mode with only a limited number of forward gears.

Some types of malfunction will make it impossible to engage all gears.

The engine may respond with reduced output when accelerating from a standing start.

If this happens, avoid extreme engine loads and consult the nearest BMW center.

 If no status messages appear in the Info Display you should accelerate carefully to confirm that you are driving in the desired direction.

Never work in the engine compartment with any of the forward or reverse gears engaged, as the vehicle could start to move. Engaging the parking brake, refer to page 62. ◀

Manual release of transmission lockout

You can respond to any interruptions in the supply of electrical power, for instance, if the battery is discharged or disconnected, by releasing the transmission lockout manually.

 To prevent the drive wheels from locking up and sliding, the transmission lockout must always be released manually before the vehicle is towed. ◀

 Press the brake pedal before releasing the transmission lockout manually. If the brakes are not applied, the vehicle could start to roll if parked on a steep slope.

The transmission lockout should only be released for towing. Remember to engage the transmission lockout when you repark the vehicle after moving it.

Should it also be necessary to release the parking brake manually, owing to a discharged battery, etc., always adhere to the following sequence:

1. Start by manually releasing the parking brake, refer to page 64
2. Then proceed to manually release the transmission lockout. ◀

Jump-starting and towing, refer to pages 207 and 208.

Releasing



1. Use the vehicle key to release the cover panel beneath the instrument panel by turning the lock counterclockwise, then fold down the cover



2. Pull out the release lever with the loop 1 until it locks into place: the transmission lockout is unlocked.

! Re-engage the transmission lockout after parking the vehicle at its destination. Otherwise there is a danger that the vehicle could start to roll if parked on a steep slope. ◀

Locking again



1. Disengage the release lever by pressing it together with the red detent lever, arrow
2. Guide the release lever all the way back into its original position – the transmission lockout is again engaged
3. Fold up and lock the cover panel again. Now – and not before – the key may be removed.

! Once the transmission lockout has been re-engaged, the warning in the Check Control should disappear, and the symbol in the Info Display should change from N to P. Should this fail to happen, there is a danger that the vehicle could start to roll. ◀

Information on jump-starting and towing begins on page 207.

Turn signal indicators/ headlamp flasher

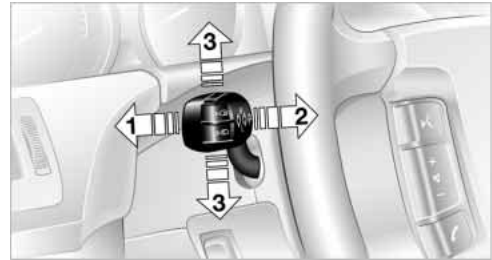

- 1 High beams: blue indicator lamp
- 2 Headlamp flasher: blue indicator lamp
- 3 Turn signal indicators: green indicator lamps, accompanied by a periodic ticking from the turn signal indicator relay

Using turn signal indicators

Move the lever beyond the resistance point. It then returns to the center position when released. Press the lever as far as the resistance point to switch off the turn signal indicators.

Signaling briefly

Press the lever up to but not beyond the resistance point. It then returns to the center position when released.

If the flashing of the indicator lamp and the ticking from the relay are both faster than normal, this indicates that one of the bulbs is defective; if a trailer is attached, this could also indicate that one of its turn signal indicator bulbs is defective.

Wiper system

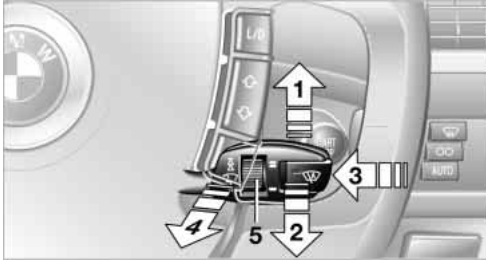

- 1 Standard wiper speed: briefly press once.
Fast wiper speed: briefly press twice
- 2 Switching off wipers or for brief wipe
- 3 Activating/deactivating rain sensor
- 4 Cleaning windshield and headlamps
- 5 Adjusting rain sensor sensitivity level

 The lever automatically returns to its initial position when released. ◀

1 Standard wiper speed

The system automatically reverts to operation in the intermittent mode whenever the vehicle is stationary.

Fast wiper speed

You can also select this position by pressing the lever upward past the resistance point.

The system automatically reverts to operation in the standard wipe mode whenever the vehicle is stationary.

4 Cleaning windshield

The system sprays washer fluid against the windshield and activates the wipers for a brief period.

Headlamp washers

Each fifth time you press into position 4 to clean the windshield while the headlamps are on.

 Do not use the washers if there is any danger that the fluid will freeze on the windshield. If you do so, your vision could be obscured. To avoid freezing, use a washer fluid antifreeze, refer to page 71. Avoid activating the washer when the reservoir is empty, as damage to the pump could result. ◀

Windshield washer nozzles

The windshield washer nozzles and the windshield itself in the area around the wipers are heated automatically when the ignition is switched on.

Rain sensor

The rain sensor is located on the windshield, directly in front of the interior rear-view mirror.

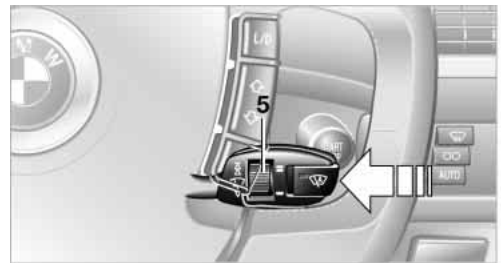

Activating the rain sensor

Briefly press the button with ignition in radio mode. The indicator lamp comes on. The wipers will always respond by completing at least one sweep of the windshield.

Adjusting rain sensor sensitivity level

Turn the serrated dial 5.

Deactivating the rain sensor

Briefly press the button again. The indicator lamp goes out.



The rain sensor is automatically deactivated when you switch off the ignition. ◀



Deactivate the rain sensor when passing through an automatic car wash. Failure to do so could result in damage caused by undesired wiper activation. ◀

Selecting wiper fold-out position

Important for changing wiper blades, when folding away from windshield to prevent blades from sticking when ice forms, etc.

1. Switch off the engine and remove the remote control from the ignition lock
2. Press the wiper lever up and maintain pressure for about 3 seconds until the wipers are roughly vertical: fold-out position.

After folding the wipers back against the windshield you will need to reactivate the wiper system:

1. Switch on the radio mode
2. Apply brief upward pressure to the wiper lever. The wipers return to their retracted position and are ready for normal operation.



To prevent damage to the wipers, always fold them back against the windshield before switching on either the radio mode or the ignition. ◀

Washer fluid



Washer fluid antifreeze is flammable. Always keep it well away from sparks and open flames, and store it in tightly closed containers well out of the reach of children. Always observe the instructions for use provided on the containers. ◀



We recommend that you mix the washer fluid before adding it to the reservoir. ◀

Windshield and headlamp washer system

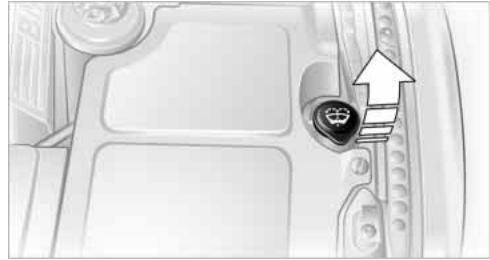

Capacity: 6.3 US quarts/6 liters.

Fill with water and – if required – with a washer antifreeze, according to manufacturer's recommendations.

Programmable cruise control

The concept

The programmable cruise control is available for use at speeds of approx. 20 mph/30 km/h and higher. The vehicle maintains and stores the speed that you set using the lever mounted on the steering column.

You can also use the multilevel preset mode to store 6 desired speeds for later selection with the same lever, refer to page 73.

This feature assists you in quickly adapting the vehicle speed to specific road conditions, e.g. changes in speeds limits.



Do not use the programmable cruise control when driving on winding roads, in heavy traffic or in poor road conditions, e.g. snow, rain, ice, loose road surface, that do not permit a constant speed. ◀

One lever for all functions

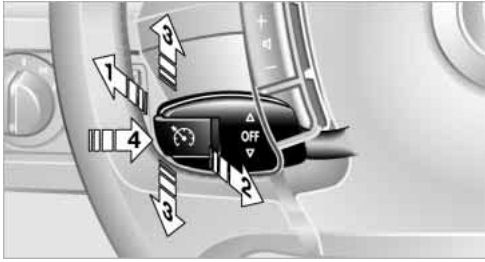

1 Maintaining and storing speed, accelerating

Press the lever as far as the resistance point:

The system maintains and stores the current vehicle speed. Every time you briefly press the lever, the vehicle's speed increases by roughly 1 mph/1 km/h.

Press the lever longer:

The vehicle accelerates without pressure on the accelerator pedal. The system maintains and stores your current speed as soon as you release the lever.

 The vehicle may accelerate beyond the preset speed on steep downhill stretches where the engine's braking effect alone may not be sufficient to slow the vehicle. Speed can drop on uphill grades if the engine output is insufficient. ◀

2 Maintaining and storing speed, decelerating

Pull lever back to resistance point:

The system maintains and stores the current vehicle speed. Every time you briefly press the lever the vehicle's speed decreases by roughly 1 mph/1 km/h.

Pull the lever longer:

The throttle aperture is automatically reduced, slowing the vehicle. The system maintains and stores your current speed as soon as you release the lever.

3 Interrupting cruise control

With the cruise control active, briefly press the lever up or down.

In addition, cruise control is interrupted automatically

- ▷ when you apply pressure to the brake pedal
- ▷ when you select neutral position of the automatic transmission
- ▷ when the DSC Dynamic Stability Control is in active operation.

4 Recalling stored speed

Briefly press button 4: the vehicle accelerates to and maintains the last speed stored.



Deactivating system

When the ignition is switched off, the system is deactivated and the stored speed is deleted.

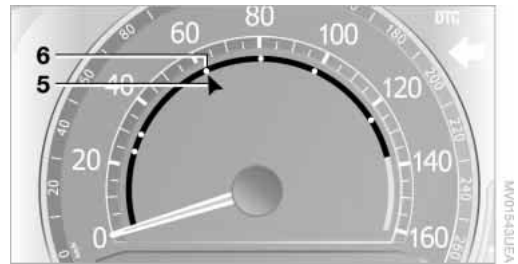
Displays in the Info Display



5 Display of speed ready for recall

- ▷  - cruise control activated
- ▷  - cruise control deactivated

6 Display of stored desired speed in the multilevel function

 5 and 6 are displayed when the system is activated. ◀

Activating multilevel preset mode

Push 1 or push 2 the lever beyond the resistance point.

The current driving speed is maintained, stored and displayed as the available speed 5.

 If no desired speeds are stored, you can increase or reduce the speed by 5 mph/10 km/h with the multilevel preset

mode activated each time you press or pull the lever beyond the resistance point. ◀

Changing preset level

Push **1** or pull **2** the lever beyond the resistance point. The preset speed progresses to the next desired speed.

 The available speed changes to the minimum speed of approx. 20 mph/30 km/h when you pull **2** the lever beyond the resistance point at the lowest desired speed. ◀

Interrupting the cruise control

With the cruise control active, briefly press the lever up or down.

Hiding display for multilevel preset mode

When activated, press the lever upward or downward for approx. 3 seconds.

Showing display for multilevel preset mode again

Press **1** or pull **2** the lever beyond the resistance point.

Deactivating the multilevel preset mode

The multilevel preset mode is also deactivated when you switch off the ignition.

Storing desired speeds

With vehicle stationary

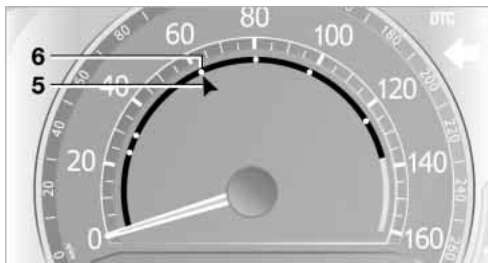

Switch on the ignition.

Press **1** or pull **2** the lever beyond the resistance point: The selectable speed level is displayed with **5**.

- ▷ To increase desired speed:
Press the lever forward
- ▷ To decrease desired speed:
Pull back the lever
- ▷ To store desired speed:
Press button **4** for approx. 3 seconds.
The stored desired speed appears in **6**.

 If 6 speeds have already been stored, it will be necessary to delete one before entering a new preset speed. ◀

While driving

Activate multilevel preset mode.

Press button **4** for approx. 3 seconds. The respective driven speed is applied as the desired speed and displayed with **6**.

 If all of the graduations flash at once, this indicates that 6 desired speeds have already been stored. You must then delete at least one. ◀

Deleting desired speeds

Select the desired speed **5**.

Press button **4** for approx. 3 seconds.

Active cruise control*

The concept

With active cruise control you can select a desired speed which is not only automatically maintained when driving on open roadways, but also varied to maintain a selected distance setting as slower traffic is encountered.

Active cruise control is a technological advance over the familiar cruise control and is a welcome relief from the constant adjustment of speed that can accompany driving in traffic on freeways or other high-speed thoroughfares. Especially on longer trips, the system can reduce fatigue and tension, while increasing your enjoyment of driving. Please use it safely and responsibly.

In addition to holding a steady cruising speed, if you do encounter slower vehicles ahead, active cruise control will – within the scope of given possibilities – adjust your vehicle's speed automatically so that one can flow with the traffic without frequent intervention by the driver. If, for example, while cruising at the selected speed, you begin to approach a slower vehicle ahead of you in the same lane, the system will reduce your vehicle's speed to the same as that of the vehicle ahead to maintain your selected distance setting between your vehicle and the vehicle ahead. There are four settings for distance, which is additionally speed-dependent. Based on your selected distance setting, the system automatically decreases the throttle setting and lightly applies the brakes if necessary. The vehicle brake lamps will automatically illuminate to signal a following driver to take action. In addition, it may be necessary for the vehicle to downshift to maintain the distance setting selected. If the vehicle ahead speeds up or when the lane ahead becomes clear, your vehicle will accelerate to the speed you have selected by increasing the throttle setting and shifting gears as needed.

 Active cruise control is not and must not be used as a collision avoidance/warning system. ◀

 Since this active cruise control system is a new technology and operates differently from conventional cruise control systems which you may be accustomed to, you are strongly urged to read all of the pages relating to this system before use. Pay special attention to the information contained in the Things to know about active cruise control section in this manual beginning on page 77. ◀

Info Display screen contents

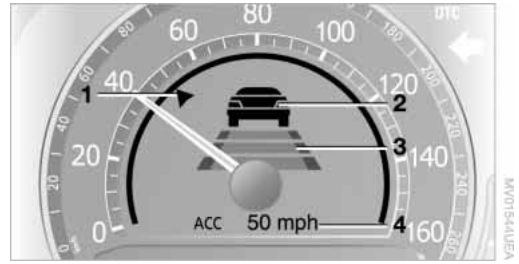

- 1 Stored desired speed display
- 2 Detected vehicle display. Lights up when vehicle driving ahead is detected
- 3 Selected distance to vehicle driving ahead
- 4 Digital speed display. Appears briefly when you select your desired speed, refer to page 75.

 The system is activated. The display appears as soon as you activate the system and no vehicle is detected driving ahead.

 Vehicle detected. The display lights up when a vehicle is detected driving ahead.

 The system requests you to intervene by braking or with an evasive maneuver. The display flashes and a chime sounds. The active cruise control cannot automatically restore the distance to the vehicle driving ahead. You will find more detailed information on page 78.

 Automatic intervention by ABS or DSC, or you actuate the parking brake while driving. The active cruise control now only intervenes by braking.

Operating the active cruise control



- 1 Activate system, store and increase desired speed
- 2 Activate system, store and decrease desired speed
- 3 Deactivate system
- 4 With system deactivated: Briefly press the button to recall the stored speed and distance
- 4 With system activated: Increase desired speed by 1 mph/ 1 km/h with each press of the button
- 5 Select distance to vehicle driving ahead. You can choose from four available distance settings. You will find more detailed information on page 76

 Adjust your desired speed to the traffic conditions and remain ready to brake at all times. Great differences in speed to the vehicles driving ahead, e.g. when quickly approaching a truck or when another vehicle swerves into your lane, cannot be compensated for by the system. ◀

Activating the system



From approx. 20 mph/30 km/h you can activate the system by pressing the lever

forward or pulling it back:

The current driving speed is stored as a desired speed and briefly displayed in the speedometer, refer to arrow.

 If the display ACC --- mph/km/h appears briefly in the speedometer, it might be that conditions necessary for operation are not currently being met. To call up Check Control messages, refer to page 83. ◀

1 Storing and increasing desired speed

Press the lever forward:

The system applies and stores your current speed as a desired speed. The speedometer indicates this speed.

Subsequently pressing forward increases the desired speed to the next 5-mile place/ 10 km/h.

Each time the lever is pressed forward again, the desired speed is increased by another 5 mph/10 km/h until a maximum of 110 mph/180 km/h is reached. The speed then displayed is stored and reached on a clear road.

2 Storing and decreasing desired speed

Pull back the lever:

The current driving speed is rounded off to the next 5-mile place/10 km/h, displayed and stored.

Each time the lever is pulled back again, the desired speed is decreased by another 5 mph/10 km/h until the minimum speed of 20 mph/30 km/h is reached. The speed then displayed is stored and reached on a clear road.

3 Deactivating the system

Press the lever up or down while the system is active. The displays in the speedometer disappear. You can use the system again as required.

In addition, the system is deactivated automatically:

- ▷ When you apply pressure to the brake pedal

- ▷ When you select the automatic transmission's neutral range N
- ▷ When you deactivate the DSC Dynamic Stability Control
- ▷ When you actuate the parking brake during driving
- ▷ When the system reduces the speed to below 20 mph/30 km/h due to a traffic situation.

 The system deactivates automatically when the speed is set to below 20 mph/30 km/h. A gong sounds and a message appears in the Check Control. The active intervention of the driver is required, otherwise there is an accident danger. ◀

Background lighting

You can switch off the background lighting of the speedometer and tachometer

- ▷ when you have deactivated the system
- ▷ when the prewarning field in the tachometer has gone out, refer to page 80
- ▷ when the destination guidance system of the navigation system is deactivated.

Press the lever up or down for approx. 1 second.

4 Resuming stored desired speed and distance setting

Press button 4:

The displays appear in the speedometer. The system is reactivated and uses the last stored desired speed and distance setting.

4 Fine adjustment of desired speed

In the activated state, the desired speed increases by 1 mph/1 km/h each time button 4 is pressed briefly.

5 Selecting distance

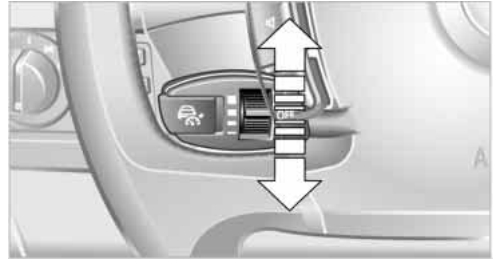

You can choose from four distance steps.

- ▷ Rotary switch upward: Increase distance
- ▷ Rotary switch downward: Decrease distance.

The selected distance is displayed in the speedometer.

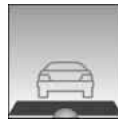

Distance 1



Distance 2



Distance 3



Distance 4

This distance is always set when the system is used for the first time after starting the engine.

 Use good judgment to select the appropriate following distance given road conditions, traffic, applicable laws and driving recommendations for safe following distance. ◀

Things to know about active cruise control

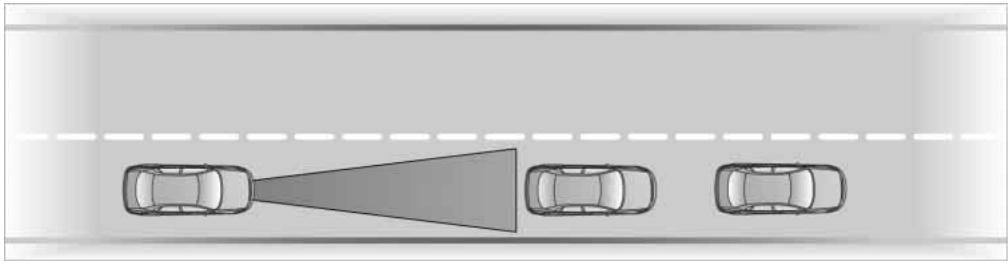

⚠ As with conventional cruise control systems, active cruise control in no way diminishes or substitutes for the driver's own personal responsibility, alertness and awareness in adjusting speed, braking or otherwise controlling the vehicle. The driver should decide when to use the system on the basis of road, traffic, visibility, and weather conditions. Active cruise control is intended for use on highway-type roadways where traffic is moving relatively smoothly. Do not use this system in city driving; heavy traffic such as during rush hour; on curvy, winding roads, slippery roads or roads with sharp curves such as highway off-ramps; during inclement weather such as snow, strong rain or fog; or when entering interchanges, service/parking areas or toll booths. It is also important to regulate your vehicle's speed and distance setting within applicable legal limits. Always be ready to take action or apply the brakes if necessary, especially when the system is actively following a vehicle in front of you. ◀

⚠ Always remember that the range and ability of the system does have physical limitations. It will not apply the brakes or decelerate your vehicle when there is a slow-moving vehicle, stopped vehicle or stationary object ahead of you, as for example, at a traffic light or a parked vehicle. Also, the system does not react to oncoming traffic, pedestrians or other type of potential traffic such as a rider on horseback. It is also possible that the system may not detect smaller moving objects such as motorcycles or bicycles. Be especially alert when encountering any of these

situations as the system will neither automatically brake, nor provide a warning to you. Also, be aware that every decrease in the distance setting allows your vehicle to come closer to a vehicle in front of you and requires a heightened amount of alertness. ◀

If while your vehicle is actively following a vehicle in front of you and the vehicle ahead speeds up or the lane ahead becomes clear, then your vehicle will accelerate to the speed you have selected. Be aware that changing to a clear, unobstructed lane will also result in your vehicle accelerating.

⚠ Be certain to deactivate the system when you pull into an exit lane for a highway off-ramp. ◀

Also, vehicles traveling in a staggered manner on a highway may cause a delay in the system's reaction to a vehicle in front of you or may cause the system to react to a vehicle actually in the lane next to you. Always be ready to take action or apply the brakes if necessary.

Active cruise control can only decelerate the vehicle to approx. 20 mph/30 km/h. If the system reduces vehicle speed below 20 mph/30 km/h or if DSC/ABS is engaged while driving, the system will automatically deactivate.

⚠ Remember, the system cannot stop your vehicle. In addition, the system is deactivated whenever the driver applies the vehicle brakes, shifts the transmission from drive/D to neutral/N, or deactivates DSC. After any deactivation, the system will no longer automatically activate the

vehicle brakes, which means the driver must intervene and resume manual braking. You should then reactivate the system only when you are fully aware of the prior speed and distance settings. ◀

Active cruise control may brake when you reduce the stored desired speed; however, the driver must constantly monitor traffic and intervene if necessary.

When you switch off the engine or ignition, active cruise control is fully switched off, too, and any settings you have selected are canceled.

Behavior in curves

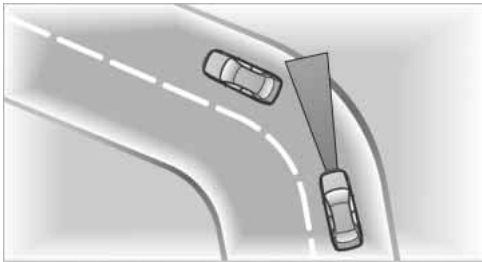

Because of the limited range of the system, it is possible that in curves or on the peaks and valleys of hilly roads, a vehicle ahead may be recognized late, or not at all. Therefore, it is up to the driver to select a speed that is prudent in view of the curves and terrain of the roadway.





In approaching a curve, it is possible that active cruise control would react briefly to a vehicle in the adjacent lane. In addition, the system can sense if your vehicle is in a curve and may not accelerate. If your vehicle decelerates in either case, you can

choose to overcome the deceleration by briefly pressing the accelerator pedal.

Driver interventions

 Remember actions by the driver always supersede and take priority over the system's automatic actions. Anytime the driver presses down on the accelerator pedal, any automatic braking action by the system is interrupted until the pedal is fully released. After doing this, release the accelerator and the system again controls your cruising speed and distance setting. While driving with activated system, resting your foot on the accelerator pedal will cause the system not to brake even if necessary. Be certain that floor mats or other objects on the vehicle floor do not interfere with movement of the accelerator pedal. ◀

 While active cruise control is capable of braking your vehicle automatically when you approach a slower vehicle ahead, it is important to be aware that the ability of the system to apply the brakes is also limited, if you are driving down a steep grade or when you reduce your desired speed sharply. The system cannot stop your vehicle. It uses only a portion of braking system capacity and does not utilize the full capacity of the vehicle braking system. Therefore, the system cannot decrease your speed for large differences in speed between your vehicle and the vehicle ahead. Examples: during emergency braking, when you approach a vehicle traveling at a much lower speed than your own speed such as approaching a toll booth or when a much slower vehicle cuts in front of you at close range. ◀

 Whenever active cruise control recognizes a situation that requires driver braking because the system capacity has been reached or has been exceeded, the system alerts the driver by flashing this symbol in the instrument cluster and sounding a chime.

Swerving vehicles

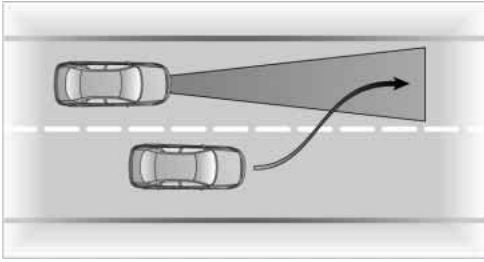

When a vehicle moves from an adjacent lane into your lane, active cruise control will not recognize this vehicle until it is fully in your lane ahead of your vehicle.

Malfunctions

The build-up of foreign material – e.g., snow, ice, dirt, road debris, etc. – can lead to reduced detection performance of active cruise control. You should check the sensor under the front bumper and clean it as necessary prior to driving your vehicle.

If the sensor becomes covered by foreign material or has a malfunction, it is possible that the sensor will no longer be able to detect vehicles in front of you. After the system recognizes that the sensor is no longer functional, a message is displayed in the Check Control and an acoustic signal is emitted, refer to page 82. Also observe the additional information provided in the Control Center.

Everything under control

Odometer, outside temperature display, clock



When the ignition is off you can briefly activate the time, outside temperature and odometer displays by pressing the knob at the upper left of the Info Display.

1 Outside temperature display, clock

The outside temperature and the time displays are active starting at the radio mode in the ignition lock.

You can change the units of measure, °F/°C, in the "Settings" menu, refer to page 88.

Setting the clock, refer to page 88.

Ice warning

A warning signal sounds when the outside temperature falls to roughly +37.5 °F / +3 °C; this is accompanied by a message in the Check Control.



Please bear in mind that the ice warning does nothing to alter the fact that glare ice may be present on roads at temperatures higher than +37.5 °F / +3 °C, for instance, on bridges and shaded surfaces. ◀

2 Odometer

The odometer panel also provides displays for the computer and the Check Control.

Regardless of the current display mode, you can view the odometer reading for a short period by pressing the knob at the upper left of the Info Display.

Check Control, refer to page 82.
Computer, refer to page 84.

3 Trip odometer

The trip odometer must be present in the display before you can reset it to zero. Reset by pressing the knob at the upper left of the Info Display.

Tachometer



The orange warning sector gradually moves upward as the engine warms to its normal operating temperature. The segments disappear in sequence as the engine warms to its normal operating temperature.

Avoid allowing the engine speed to rise as far as the orange warning sector whenever possible.

Service Interval Display

Displays in the Info Display

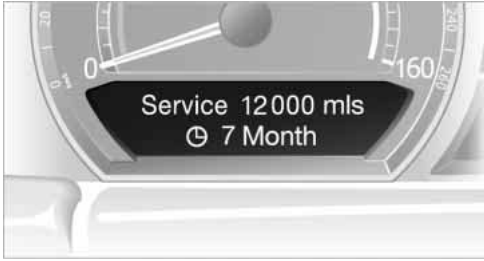

The distance/period remaining until your next service briefly appears when you switch on the ignition.

 The Info Display immediately switches to its computer mode when you press one of the two buttons in the turn signal indicator lever, refer to page 84. ◀

Displays in the Control Display



You can view additional information on service and maintenance procedures by selecting the "Car data" menu.

1. Select  and confirm

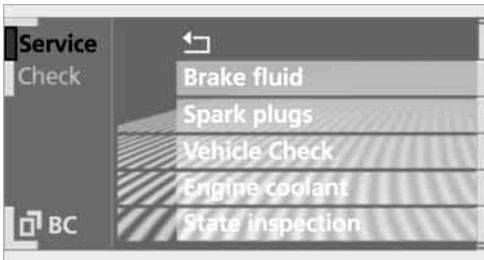

2. Select "Service" and confirm

3. The display shows a list of selected service and maintenance procedures, as well as legally-mandated official inspections.

Red sectors

The service deadline has already passed.

Yellow sectors

The deadline for service or an official inspection is approaching. Please contact your BMW center for an appointment.

Green sectors

No service is currently required. If you desire, certain maintenance operations can be carried out at the next service at the customer's request.

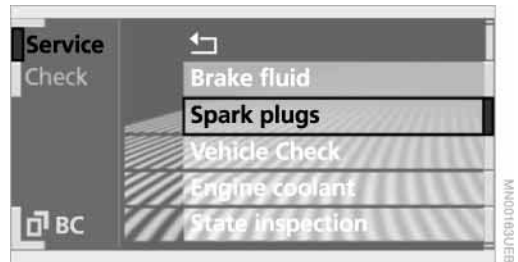



You can request more detailed information on every entry.

Turn the controller to scroll through the list, then confirm the selected entry.

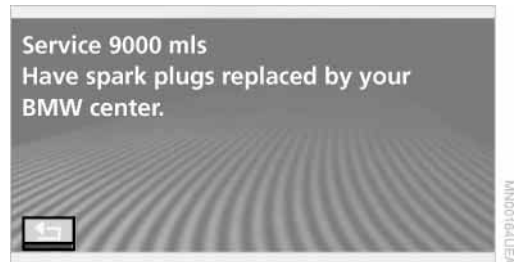
Confirm  or turn the controller to exit from the list.



The display disappears when the  symbol is confirmed.

 The Service Interval Display does not continue counting down to the next service during periods when the vehicle is stored with the battery disconnected or the battery switch OFF.

Please remember that brake fluid should be changed every two years at the latest, even if the display does not yet indicate that service is required, refer to page 197. This same precaution applies to all of the other service and maintenance operations scheduled according to periodic intervals. ◀

Displaying and entering dates for legally prescribed emission and vehicle inspections

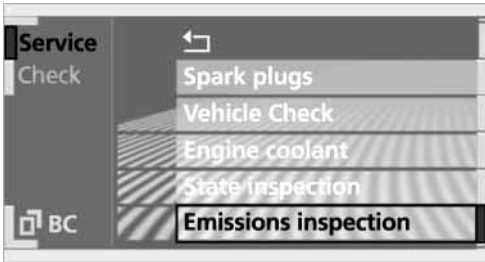

1. Select "Emissions inspection" or "State inspection" and confirm
2. Turn the controller to select date input



3. Confirm the inspection date. The first part of the date entry is activated – here month.
 - ▷ Turn to reset
 - ▷ Press to store and move to the next entry – here year.
 The system applies the date of the last entry stored.

4. Press the controller to select "CONFIRM".

 A requirement is that you have correctly set the date and time in the Control Center, refer to page 88. ◀

Displays in the Info Display



If the deadline for your next emissions or state vehicle inspection is approaching, the remaining distance and time will appear briefly when you switch on the ignition.

 Your Service Advisor will determine your vehicle's current service requirements by reading out the data stored in the vehicle's key. ◀

Check Control

Messages and indicator lamps in the Info Display



Messages and faults in systems appear in text form accompanied by an indicator lamp symbol. The alert is accompanied by a gong.

Reports are assigned one of two priority ratings:

Priority 1:

These status messages and malfunction reports are signaled by a gong. Simultaneous defects will be displayed consecutively. These messages cannot be deleted, and they remain in the display until the problem is corrected. Supplementary information is also shown on the Control Display, refer to Automatic display on the Control Display.

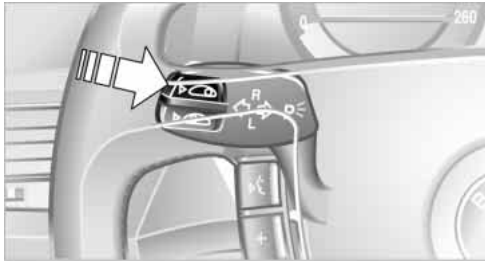

Priority 2:

These status messages and malfunction reports appear in the Info Display for approx. 20 seconds.

Briefly press the CHECK button on the turn signal indicator lever to cancel the message in the display, if allowed by priority rating.

Requesting stored messages using the Control Center see there.

Check Control symbol and messages on the Control Display

Depending on the status of the monitored systems, the Check Control symbol is displayed in different colors.

Yellow or red

Faults are present in the monitored systems. Depending upon how serious the problem is, a supplementary message may also appear on the Control Display.

Requesting stored messages using the Control Center see there.

The symbol in the status line also indicates the status of the Service Interval Display, refer to page 23. ◀

Automatic display on the Control Display

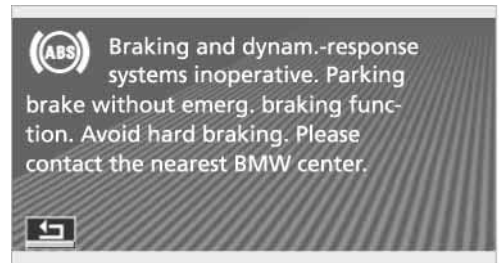

These supplementary messages are intended to assist you in assessing the severity of malfunctions; they provide you with the information you need to decide on the best way to respond.

Select and confirm to switch off the display.

Requesting stored messages using the Control Center



1. Select "Car data"
2. Select and confirm

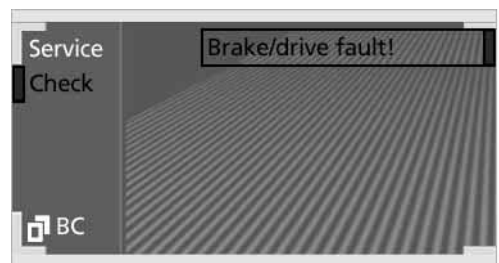

3. Select "Check" and confirm
4. The stored status reports appear in the display. Select the desired report and confirm.

The display disappears when the  symbol is confirmed.

Displays after completion of trip

Selected fault reports generated during the trip are shown consecutively when you switch off the ignition.

If indicated, the following message may also appear:

"Parking lamps on!"

This message appears when you open the driver's door after parking. A supplementary gong is also heard.

Even with the ignition and Info Display off, you can reactivate the screen and display the messages.

Press the CHECK button for approx. 8 seconds, refer to page 83. The stored status reports appear again in the display. If several messages are present, you can continue to briefly press the CHECK button to view them in succession.

The Check Control function

- ▷ cancels itself automatically after a brief period
- ▷ can be canceled by again pressing the CHECK button for approx. 8 seconds.



You can select the language in which Check Control status reports and messages from the computer will appear, refer to page 88. ◀

Computer

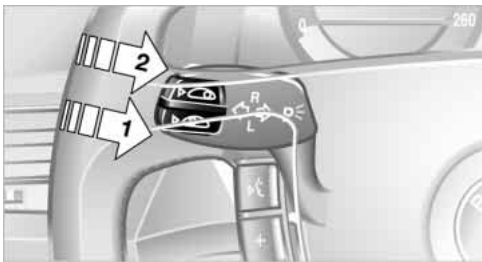

To select functions:

You can use the buttons in the turn signal indicator lever to request a display from the

computer on the Info Display, starting at the radio mode in the ignition lock.

- 1 Info Display on left
- 2 Info Display on right

A new function appears each time you briefly press the button.

Displays in the Info Display

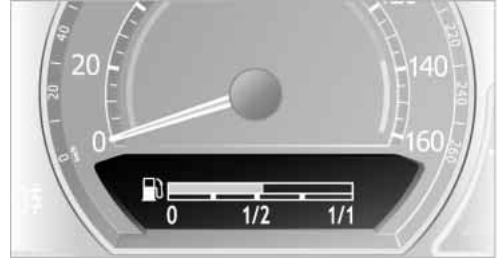

The display sequence:

- ▷ Fuel gauge 85
- ▷ Range and remaining distance 85.



The display sequence:

- ▷ Odometer 80
- ▷ Energy Control/
Current fuel consumption 85
- ▷ Average fuel consumption 85
- ▷ Average speed 85
- ▷ Time of arrival 85.



Maintain pressure on button 1 to cancel the display from the computer.

Briefly press the button again to return to the last display.

It will not be possible to cancel the display if the fuel level has fallen into the reserve range or if a Check Control status report is currently on the screen.

Briefly press the button again to view the last display. ◀

Fuel gauge

The fuel gauge display appears automatically once the fuel level falls into the reserve range. At the same time, the words "Fuel reserve" appear. The tank still contains approx. 2.6 gallons/10 liters of fuel.

 It will not be possible to cancel the computer display once the fuel level drops into the reserve range. However, you can still request a display of the travel range. Computer, refer to page 84. ◀

Tank capacity: approx. 23.2 gallons/88 liters. You can find information on refueling on page 186.

If the tilt of the vehicle varies, when you are driving in mountainous areas, for example, the indicator may fluctuate slightly.

 Refuel well before the tank is empty, as otherwise engine functions will not be ensured and damage can occur if you drive down to the last drop. ◀

Cruising range

Displays the estimated cruising range available with the remaining fuel. The system calculates the cruising range based on operating conditions and the amount of fuel remaining in the tank. The basis for the calculations is the average fuel consumption over the preceding 20 miles/30 km.

 Always refuel as soon as possible once your range falls to below 30 miles/50 kilometers, as otherwise engine functions are not ensured and damage can occur. ◀

Refueling is only registered by the computer for fuel amounts above approx. 1.3 gallons/5 liters.

Remaining distance

When you enter a destination in the navigation system or manually enter a distance in the computer prior to departure, the system can also display the distance remain-

ing to your destination, refer to page 132 or 86.

The system automatically applies the distance to your destination using the route recommended by the navigation system.

 When you enter a destination in the navigation system, any manual entries will be overwritten no later than once 1,640 ft/500 meters of the calculated distance have elapsed. ◀

Energy Control/ Current fuel consumption

Shows the current fuel consumption. This allows you to see whether your current driving style is conducive to fuel economy with minimum exhaust emissions.

Average fuel consumption

The average fuel consumption is calculated for the time during which the engine is running.

You can use the Control Display to view your fuel consumption rate over two different distances, refer to Computer or Trip computer.

Average speed

Periods with the vehicle parked and the engine off are not included in the calculations of average speed.

Time of arrival

A display of your estimated time of arrival is available whenever you enter a destination in the navigation system, refer to page 132, or enter the distance manually in the computer, refer to page 86, prior to departure.

 A requirement is that you have correctly set the time in the Control Center, refer to page 88. ◀

Displays in the Control Display

You can activate the computer function at any time by selecting it from the "Car data" menu.

You have two possibilities to display information of the computer:

- ▷ Computer
- ▷ Trip computer
 - It is best to use this for driving on vacation, as when you reset the values to zero, all the functions are reset together and then restart.

Computer



- ▷ Time of arrival
- ▷ Distance to destination.
Enter a destination in the navigation system, or enter a distance in the computer manually, refer to page 132 or 86
- ▷ Cruising range
- ▷ Average fuel consumption
- ▷ Average speed.

 You can reset calculations of both average speed and average fuel consumption to zero. Select the menu item and confirm. ◀

Trip computer

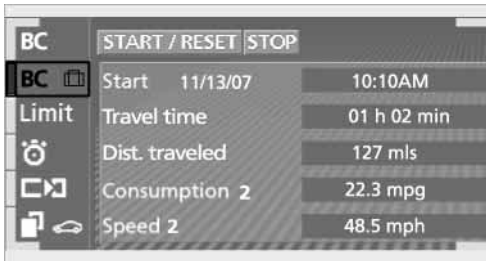

Reset all data to zero:
Select "START / RESET" and confirm.

- ▷ Time of departure
- ▷ Driving time
- ▷ Elapsed distance

- ▷ Average fuel consumption since "START / RESET"
- ▷ Average speed since "START / RESET".

Entering a distance manually

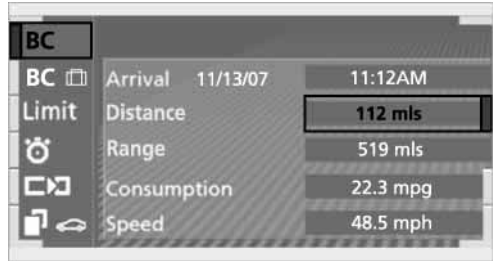

1. Select computer "BC"
2. Select and activate the "Distance" entry function. Turn the controller to the left or right to select the distance to your destination
3. Press the controller to confirm your entry.

Speed limit

You can enter a speed and a Check Control message indicates when you have reached this speed. This enables you, for example, to receive warnings if you exceed a speed limit in an urban area.

You are only warned of reaching this speed a second time if you again drive at least 3 mph/5 km/h slower.

Adjusting, changing



1. Select "Limit" and confirm
2. Select "SET" and confirm

- Turn the controller to the left or right to select the preset speed
- Press the controller to confirm your entry. The speed limit function is now active.

Switching on or off

- Select "Limit" and confirm
- Select "ON / OFF" and confirm. "ON / OFF" is highlighted when the speed limit function is activated.

Applying your current speed as the limit

- Select "Limit" and confirm
- Select  and confirm. The system applies your current speed as the limit.

Limit in Info Display

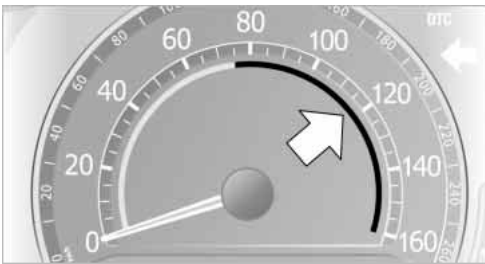



If, for instance, the warning sector in the tachometer is visible, refer to page 80, the

speed limit will be indicated by a warning sector in the speedometer, refer to arrow.

Stopwatch



Starting and stopping

- Select  and confirm
- Select  and confirm. The stopwatch is reset to 0 and starts
- Select  and confirm. This stops the timer. Confirm again to reset the stopwatch to zero.

Taking an intermediate time reading

Select "INTERM. TIME" and confirm. This intermediate time appears below the ongoing primary stopwatch count.

-  All of the remaining functions remain available at all times while the stopwatch is running. The stopwatch continues operation in the background. ◀

Assistance window* for "Car data"

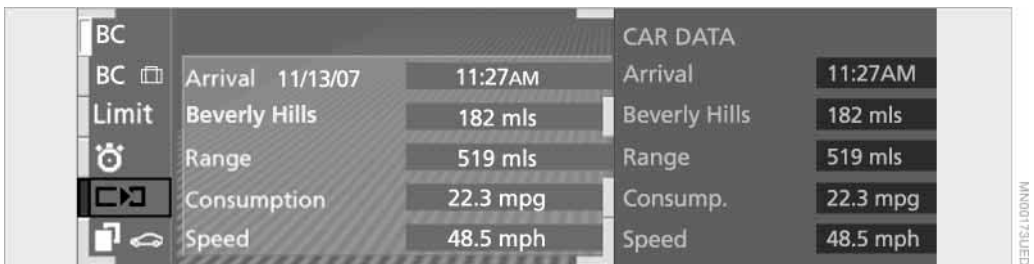



You can select any of the following computer functions for display in the assistance window:

- ▷ Computer

- ▷ Trip computer
- ▷ Speed limit
- ▷ Stopwatch.

Applying display

1. Select the desired function and confirm - here computer "BC"
2. Select  and confirm. The function appears in the assistance window.

 The  symbol is highlighted if the function displayed in the assistance window is selected on the Control Display. ◀

You can also choose to view brief help texts explaining selected menu items, refer to page 22, or the travel route on vehicles equipped with a GPS navigation system, refer to page 131.

Changing settings

Units of measure and display format

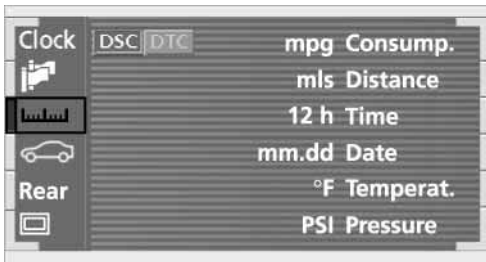

You can select the units of measure used in the displays of fuel consumption, distances, temperatures and pressures as well as the display format for the time and date.

1. Select  and confirm
2. Select the menu item that you wish to adjust. Press repeatedly to view a listing of your selection options.

Language



You can select a different language for the text displays.

1. Select  and confirm
2. Select and activate the desired language.

Time and date



Select "Clock" and confirm.

Setting the time

Select "Time" and confirm. The first setting sector is highlighted.

- ▶ Turn to reset
- ▶ Press to store your entry and proceed to the next setting.
The clock applies the last saved entry.

Switching on the memo mode

You will hear four tones just before each full hour.

- ▶ Select "Memo" and confirm. "Memo" is highlighted when this function is activated.

Setting the date

Select "Date" and confirm. The first section of the date display is highlighted – here day.

- ▷ Turn to reset
- ▷ Press to store and highlight the next entry – here month and year.
Your date is applied by the system the last time you store your entry.

Brightness



You can set the brightness of the screen.

1. Select  and confirm.

Select "Brightness" and confirm. Press and turn the controller to make the adjustment.

- ▷ With unfavorable conditions, e.g. bright environment, the brightness control of the screen might not be immediately recognizable. ◀

Technology for comfort, convenience and safety

PDC Park Distance Control*

The concept

The PDC assists you when you are parking. Signal tones indicate the current distance to an object behind or in front of your vehicle. Four ultrasonic sensors in both the bumpers monitor the distance to the nearest object. The sensors at the front and at the two rear corners have a range of approx. 2 ft/60 cm; the rear middle sensors have approx. 5 ft/1.50 m.

 PDC is a parking aid that can indicate objects when they are approached slowly, as is usually the case when parking. Avoid approaching an object at high speed, as otherwise the physical circumstances would mean that the system warning was too late. ◀

Automatic function

Whenever the ignition is on the system automatically assumes operational status after a few seconds each time you engage the transmission position R.

 Wait this short period before reversing. ◀

Manual activation



Press the button, the indicator lamp lights up.

Manual deactivation

Press the button again; the indicator lamp goes out.

Automatic deactivation

The system is automatically deactivated once the vehicle travels approx. 165 ft/50 m or exceeds a speed of roughly 20 mph/30 km/h; the indicator lamp goes out. You can reactivate the system manually as needed.

Signal tones

The signal indicating the distance to the nearest obstacle is directional. Thus, an object detected to the left rear of the vehicle will be indicated by a signal tone from the left rear speaker, etc. As the distance between vehicle and object decreases, the intervals between the tones become shorter. The signal tone becomes continuous once the distance to the nearest object falls to below roughly 1 ft/30 cm.

The warning signal is canceled after approx. 3 seconds if you are moving parallel to a wall.

Malfunctions

The indicator lamp within the button flashes and a status message appears in the Check Control.

Please take note of the additional information on the Control Display.

Switch the system off and have the cause of the malfunction corrected by your BMW center.

PDC with visual warning



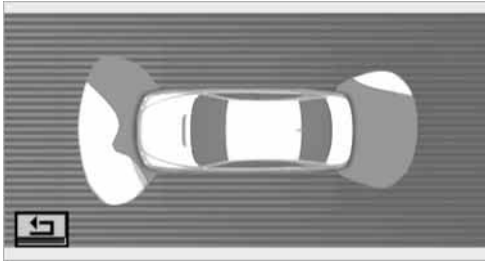

You also enjoy the option of having the system show distances to objects on the Control Display. The Control Display will also indicate the presence of objects in green before they are close enough to generate a signal tone.

Select "PDC pic." from the "Settings" menu and confirm. This activates the PDC display.



The display then appears on the Control Display whenever the PDC is automatically or manually activated.

The previous display automatically reappears after the system is deactivated.

 Confirming the menu item  takes you back to the previous display. ◀

Limits of the system

 Even with PDC, final responsibility for estimating the distance between the vehicle and any obstructions always remains with the driver. Even when sensors are involved, there is a blind spot in which objects cannot be detected. The system is also subject to the physical limits that apply to all forms of ultrasonic measurement, such as those encountered with tow bars

and trailer couplings, as well as thin and wedge-shaped objects, etc. Low objects already displayed, e.g. a curb, can also disappear from the detection area of the sensors again before a continuous tone sounds.

Loud noises from outside and inside the vehicle may prevent you from hearing PDC's signal tone. ◀

 Keep the sensors clean and free of ice or snow in order to ensure that they will continue to operate effectively. Do not apply high pressure spray to the sensors for a prolonged period of time. Keep the spray at least 4 in/10 cm away from the sensors. ◀

Driving stability control/ ABS Antilock Brake System

The concept

ABS enhances active safety by preventing the wheels from locking under braking.

ABS incorporates CBC and EBV.

In case of malfunction

 If the indicator lamp lights up in yellow, this indicates that ABS has been deactivated in response to a system malfunction. Conventional braking efficiency remains available without limitations. Please have the system inspected at your BMW center.

CBC Cornering Brake Control

CBC is a supplement to ABS. It provides further enhancements in vehicle stability and steering response during lane changes and cornering at high rates of lateral acceleration.

EBV Electronic brake-force distribution

EBV controls the brake system's application pressure at the rear wheels to ensure stable deceleration.

In case of malfunction



If the brake system warning lamp lights up in red, together with the yellow indicator lamps for ABS and DSC: the stability control is no longer operational.



If all three lamps light up in yellow: malfunction in the stability control systems. The electronic brake-force distribution is active.

While you may continue, you should remember to proceed cautiously and drive defensively while avoiding full brake applications.

Please have the system checked at the nearest BMW center.

Check Control messages, refer to page 82. Please take note of the additional information on the Control Display.



Indicator and warning lamps on Canadian models.



Driving stability control/ DSC Dynamic Stability Control

The concept

DSC maintains vehicle stability, even in critical driving situations.

The system optimizes vehicle stability during acceleration and when starting from a full stop, as well as optimizing traction.

The system recognizes any tendency for the vehicle to assume an unstable attitude such as oversteer or understeer; it then counteracts this tendency with a combination of graduated reductions in engine torque and selective braking intervention at individual wheels. DSC provides optimized

stability within the limits defined by the laws of physics.

The DSC is operational every time you start the engine. DSC includes the functionality of the DTC Dynamic Traction Control and DBC Dynamic Brake Control.

Indicator lamps



The indicator lamp in the Info Display goes out soon after you start the engine.

If the indicator lamp flashes:

DSC controls the drive and braking forces.

The indicator lamp stays lit:

DSC has been switched off using the Control Center.



The indicator lamp and the brake warning lamp remain on continuously:



DSC, DTC and DBC have been deactivated or a system malfunction is present.

When the system is off, the stability maintenance functions described above are no longer available. The vehicle will remain completely operational, however, without DSC.

Please respond to any malfunctions by referring the problem to your BMW center.



Indicator and warning lamps on Canadian models.



DTC Dynamic Traction Control

In particular driving situations, in deep snow, for example, DTC ensures the maximum forward momentum. The gain in forward momentum in these situations involves a reduction in vehicle stability. DTC is active up to 45 mph/70 km/h.

Activating DTC

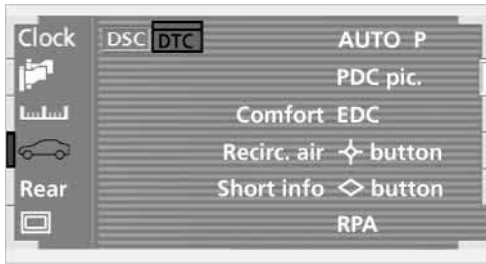

You may find it useful to briefly activate DTC under the following special circumstances:

- ▷ When rocking the vehicle and starting off in deep snow or on loose road surfaces
- ▷ When ascending snow-covered hills, and when driving in deep or on hard-packed snow
- ▷ When driving with snow chains.

Select "Settings". Select "DTC" and confirm. DTC is now activated. The DTC indicator lamp in the Info Display lights up permanently.

 When DTC is active, DSC provides only limited system response up to a speed of approx. 45 mph/70 km/h. Intervention for stability enhancement is reduced. ◀

Deactivating DTC again

Select "Settings". Select "DTC" and confirm. DTC is now deactivated. The DTC indicator lamp in the Info Display goes out. DSC is once again available without restriction.

Switching off DSC

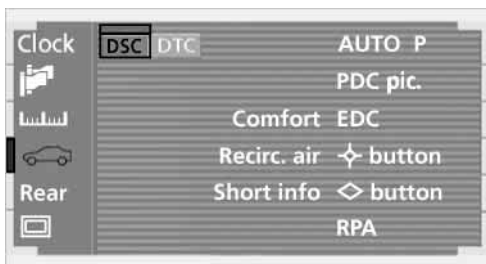

Select "Settings". Select "DSC" and confirm. DSC is deactivated. The indicator lamp in the Info Display remains on continuously.

Deactivating DSC automatically deactivates DTC as well. The systems for enhancing stability and traction are deactivated, and there is no active braking intervention or torque control.

A status report appears in the Check Control. Please take note of the additional information on the Control Display.

 To maintain optimized stability, drive with the system on whenever possible. ◀

Reactivating DSC

Select "Settings". Select "DSC" and confirm. DSC is now activated. The indicator lamp in the Info Display goes out.

 The laws of physics cannot be repealed, even with DSC. An appropriate driving style always remains the responsibility of the driver. Avoid using the additional safety margin provided by the system as an excuse for taking unnecessary risks.

When DTC is active, DSC provides only limited system response up to a speed of approx. 45 mph/70 km/h. Intervention for stability-enhancement is reduced.

Do not make any modifications to the DSC system. Never allow anyone other than authorized professional technicians to carry out service or repairs on the DSC system. ◀

DBC Dynamic Brake Control

When you apply the brakes rapidly, this system automatically produces the maximum braking force boost and thus helps to achieve the shortest possible braking distance during panic stops. This system exploits all of the benefits provided by ABS.

Do not reduce the pressure on the brake pedal for the duration of the brake application. When the brake pedal is released, the DBC is deactivated.



In the event of a malfunction, the warning lamp lights up yellow. Have the system checked and repaired at your BMW center as soon as possible. Check Control messages, refer to page 82. Please take note of the additional information on the Control Display.



Warning lamp on Canadian models.

Dynamic Drive

The concept

Dynamic Drive minimizes body roll and optimizes vehicle stability during cornering and evasive maneuvers.

Active stabilizers at the front and rear axles form the basis for Dynamic Drive. Suspension compliance adapts to suit driving conditions, varying from performance-oriented during cornering to smooth and comfort-oriented when the vehicle is proceeding in a straight line.

The system assumes operational status each time you start the engine.

Driving with Dynamic Drive

During vehicle operation, the system continuously runs through closed-loop control cycles lasting only fractions of a second.

In case of malfunction



The symbol will light up, accompanied by a status message in the Check Control. Please take note of the additional information on the Control Display.

You can find more information on the Check Control starting on page 82.



If the Dynamic Drive system switches off in response to malfunction, please remember to adapt your speed accordingly, especially in curves.

The suspension will be noticeably softer and the vehicle will display a greater ten-

dency to tilt during cornering and in crosswinds.

If a Check Control message stating that you should stop appears in addition to the red symbol, stop immediately and switch off the engine. In this case the oil level in the reservoir may have dropped below the minimum, possibly owing to a leak in the hydraulic system.

Please observe the additional instructions provided on the Control Display. ◀

EDC Electronic Damping Control*

The suspension responds to changes in factors such as road surface, or operating conditions such as steering and braking, by adapting to the new conditions within fractions of a second.

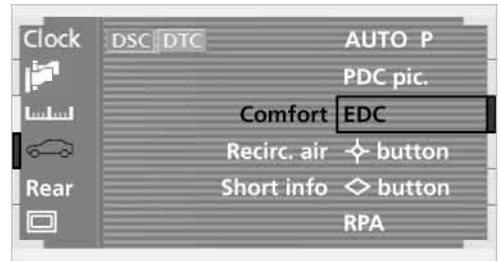

Two programs are available; they can be selected in the "Settings" menu.

Comfort program

The Comfort program is suitable for use throughout the vehicle's entire speed range and regardless of load.

Sport program

You should select the Sport program for consistently performance-oriented response from shock absorbers and steering.

Flat Tire Monitor

The concept

The Flat Tire Monitor keeps track of the inflation pressures in the four fitted tires as you drive. The system provides an alert whenever the inflation pressure of one tire drops significantly in relation to the pressure of another tire.

The check of the tire inflation pressure is based on monitoring the relative speeds of the wheels. A flat tire is detected and reported on the basis of a deviation in certain speed ratios.

Functional requirements

So that the Flat Tire Monitor can learn the correct inflation pressure, please perform the following:

1. Check the inflation pressures in all tires
2. Compare with the inflation pressure table on page 189 and correct if necessary
3. Initialize the system.

Limits of the system

 The Flat Tire Monitor cannot indicate sudden severe tire damage caused by outside factors and does not detect a natural, even pressure drop in all four tires. ◀

In the following situations, on the other hand, there can be delays in detecting tire pressure losses, and even system failure:

- ▷ When you are driving on snow-covered or slippery road surfaces
- ▷ In the case of performance-oriented driving: slip on the drive wheels, high lateral acceleration
- ▷ False alarms and undetected loss of pressure may occur when you are driving with snow chains fitted.

Initializing the system

 Perform the initialization immediately after correcting the inflation pressure, changing a tire or changing a wheel or all wheels. A drive is necessary for this purpose. ◀

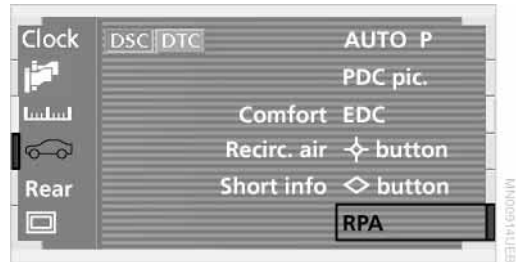

1. Start the engine, but do not drive off
2. Select "FTM" from the "Settings" menu and confirm. The initialization menu appears

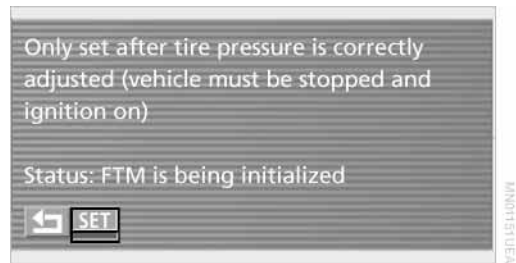

3. Select "SET" and confirm
4. Drive off.

Status: "FTM is being initialized" is displayed.

It takes at least 10 minutes before the Flat Tire Monitor can detect and report a flat tire.

 When driving with snow chains, do not initialize the system. ◀

Select  and confirm to exit from the menu.

Flat tire

Indicator lamp



The symbol in the Info Display lights up red and a message appears simultaneously. In addition, an acoustic signal sounds.

Please note any supplementary information that appears on the Control Display. You can find more information on the Check Control starting at page 82.

1. Reduce speed and stop the vehicle carefully. Avoid sudden braking and steering maneuvers
2. Identify damaged tire
 -  If identification is not possible, contact your BMW center. ◀
3. Replace the damaged tire, refer to Changing wheels on page 202.

Vehicles with run-flat tires:

1. Cautiously reduce the vehicle speed to below 50 mph/80 km/h. Avoid sudden braking and steering maneuvers. Do not exceed a vehicle speed of 50 mph/80 km/h
 -  Due to the reinforcement on the side walls of the run-flat tires, inflation pressure loss can not usually be recognized from the outside, refer to Run-flat tires on page 205. ◀
2. To continue driving, comply with the instructions for driving with damaged tires on page 205.

System malfunctions

Indicator lamp



The symbol in the Info Display lights up yellow and a message appears simultaneously. Please contact your BMW center for assistance.

Please note any supplementary information that appears on the Control Display.

Self-leveling suspension*

In the event of malfunction



A Check Control message appearing together with this symbol indicates a malfunction in the self-leveling suspension. Please take note of the additional information on the Control Display.

Stop and inspect the vehicle. If the rear of the vehicle is visibly lower than the front, possibly accompanied by a tilt noticeable when you compare the left rear with the right rear, please respond by immediately proceeding to the nearest BMW center. Drive with appropriate caution in the meantime. The vehicle has reduced ground clearance and driving comfort may be noticeably reduced. Even if the attitude of the vehicle is normal, you should consult the nearest BMW center if the warning lamp indicates a system fault.

Brake force display

The Brake force display indicates the intensity with which you are applying your brakes to drivers of following vehicles.



The display consists of two stages:

- ▷ Normal braking:
The brake lamps in the tail lamp assemblies and the high-mount brake lamp on the rear tray light up during braking
- ▷ Heavy braking and braking with ABS:
The tail lamps also light up with the same intensity as the standard brake lamp units to enhance the warning effect of the brake lamps.



The following airbags are located under the marked covers:

- 1 Front airbags for driver and front passenger
- 2 Head airbags in front and rear
- 3 Side airbags in front and rear*
- 4 Knee airbags for driver and front passenger

Protective effect

The front airbags help protect the driver and front passenger by responding to frontal impacts in which safety belts alone cannot provide adequate restraint. When needed, the head and side airbags help provide protection in the event of side impact. The side airbags help restrain the side of the occupant's upper torso, and the head airbags help support the head while also helping provide protection against any objects penetrating into the passenger compartment. The knee airbags help protect the legs against impact against the cockpit.

The airbags are deliberately not triggered in every impact situation, e.g. less severe accidents, certain roll-over conditions, or rear-end collisions.

 The rear seat side airbags may already have been deactivated by a BMW center. Labels in the rear door opening should indicate the status of your rear seat side airbags. If you are uncertain of their status, or wish to have the airbags activated or deactivated, please contact your BMW center. ◀

For information on the correct sitting position, refer to page 44.

 Do not apply adhesive materials to the cover panels of the airbags, cover them or modify them in any other way. Do not attempt to remove the airbag retention system from the vehicle. Never modify or tamper with either the wiring or the individual components in the airbag system. This category includes the upholstery in the center of the steering wheel, on the instrument panel, the side trim panels on the front or rear doors, and the roof pillars along with the sides of the headliner. Do not attempt to remove or dismantle the steering wheel. Do not touch the individual components directly after the system has been triggered, because there is a danger of burns. If you note any indication of system malfunction, if you desire to have an airbag deactivated, or if the airbag retention system is triggered in response to an accident, you should always entrust all inspection, repair and dismantling operations to your BMW center.

Unprofessional attempts to service the system could lead to failure in an emergency or undesired airbag activation, either of which could result in personal injury. To ensure compliance with official safety regulations, entrust disposal of airbag generators to a BMW center. ◀

Airbag warning information is also provided on the sun visors.

Indicator lamp

Operational readiness of airbag system



The airbag warning lamp in the Info Display indicates the operational readiness of the entire airbag system and the safety belt tensioners as of ignition key radio position.

The indicator lamp goes out after a few seconds.

Airbag system malfunction



A system malfunction could prevent the system from responding in the expected manner to an impact occurring within its normal response range. Have the airbag system inspected immediately at a BMW center. ◀



There is a fault in the airbag system if the airbag warning lamp behaves as follows:

- ▷ The indicator lamp fails to come on as of ignition radio position
- ▷ The indicator lamp remains on continuously
- ▷ Indicator lamp lights up while the vehicle is being driven.

Lamps

Parking lamps/low beams

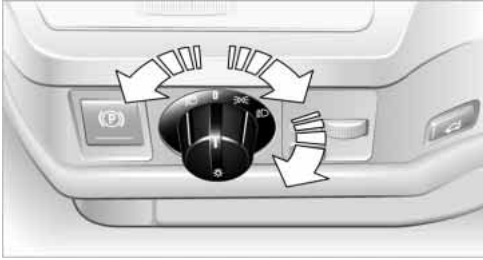

Parking lamps



With the switch in this position, the front, rear and side vehicle lighting is switched on. You can use the parking lamps for parking. For lighting on one side for parking as an additional feature, refer to page 100.

Low beams



When you switch off the ignition with the headlamps on, the headlamps go out, and only the parking lamps remain on.



Pathway lighting: After parking the vehicle and switching off the headlamps, you can use the headlamp flasher control to activate the low beams for a period of roughly 40 seconds. You also have the options of extending this period or, as an alternative, having this function deactivated. ◀

Lights on warning

If you switch off the ignition while the headlamps are on, when you subsequently open the driver's door a gong will sound for several seconds, while the Check Control will provide you with a message.

Daytime driving lamps*

If you wish, you can leave the light switch in the low-beam position.

Always observe all applicable laws governing the use of daytime driving lamps.

You can switch on the parking lamps when needed using the standard procedure described under Parking lamps.



You can have the daytime driving lamps on your vehicle programmed to operate as desired. ◀

Automatic headlamp control



When you set the switch to this position, the system activates and switches on and off the low beams in response to changes in ambient light conditions, for instance, in tunnels, at dawn and dusk, and in rain and snow. The green indicator lamp next to the symbol is illuminated when the low beams are on.



Following automatic activation, the vehicle's external lighting remains on when you switch on the fog lamps. ◀



The automatic headlamp control cannot serve as a substitute for your personal judgment in determining when the lamps should be switched on in response to ambient lighting conditions. For example, the system cannot detect fog. To avoid safety risks, you should always switch on the lamps manually under these conditions. ◀



You can have the sensitivity of the headlamp control system adjusted on your vehicle. ◀

Adaptive Head Light*

The concept

Adaptive Head Light is a variable headlamp control system that enables dynamic illumination of the road surface. Depending on the steering angle and other assumptions, the light from the headlamp follows the course of the road.

Activating the Adaptive Head Light



With the ignition on, refer to page 60, turn the light switch to the position Automatic headlamp control, refer to page 99.



When the vehicle is backing up, the Adaptive Head Light is inactive; when the vehicle is at a standstill, it is only active in one direction. ◀

In case of malfunction

The LED above the symbol for automatic headlamp control flashes, refer to page 99. Please have the system inspected at your BMW center.

Instrument lighting



Turn the serrated dial to adjust the illumination intensity.

High beams/standing lamps

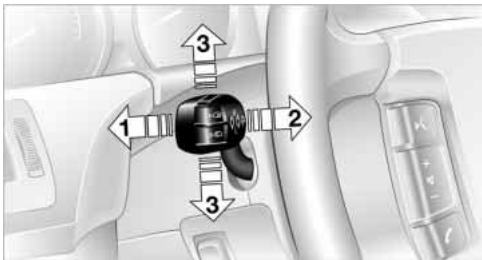

- 1 High beams: blue indicator lamp
- 2 Headlamp flasher: blue indicator lamp
- 3 Standing lamps

Standing lamps, left and right*

You also enjoy the option of lighting up just one side of your vehicle when parking:

With the ignition off, press the lever in the desired direction 3, past the resistance point.

Front fog lamps



The parking lamps or low beams must be switched on for the fog lamps to operate. The green indicator lamp in the Info Display lights up whenever the fog lamps are on.

Briefly press the button once again to switch off.

The fog lamps are switched off whenever the high beams are switched on.



If the automatic headlamp control is activated, the low beams will come on automatically when you switch on the fog lamps. ◀

Interior lamps

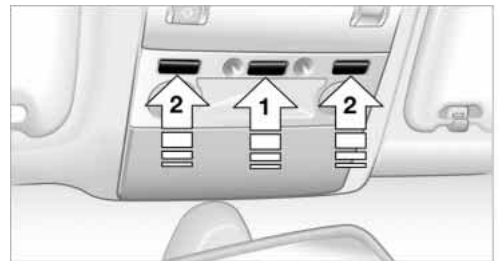

The interior lamps operate automatically.

Switching the interior lamps on and off

Briefly press button 1.

If you want the interior lamps to remain off continuously, maintain pressure on the button for approx. 3 seconds.

To revert to normal operation, briefly press the button.

The button for the interior lamps in the rear passenger area only switches these lamps on and off.

Control of the footwell lamps, courtesy lamps and ground lamps is also automatic.

Reading lamps

Reading lamps are provided in the front and rear, adjacent to the interior lamps. You can switch them on and off with button 2 adjacent to each lamp.



To avoid discharging the battery, all of the vehicle's interior lamps are automatically extinguished approx. 15 minutes after the ignition is switched off. ◀

Light-emitting diodes LEDs

Light-emitting diodes installed behind translucent lenses serve as the light source for many of the controls and displays in your vehicle. These light-emitting diodes, which operate using a concept similar to that applied in conventional lasers, are officially designated as Class 1 light-emitting diodes.



Do not remove the covers, and never stare into the unfiltered light for several hours, as irritation of the iris could result. ◀

A congenial climate

Automatic climate control

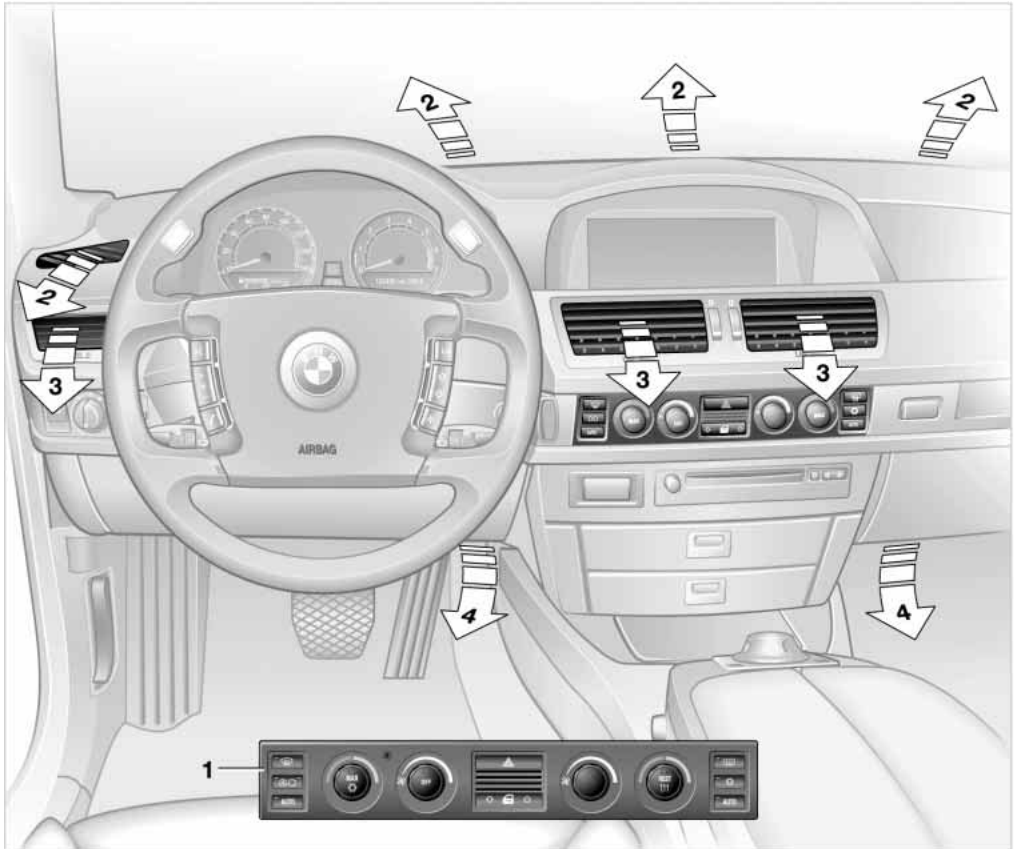

- 1 Automatic climate control
- 2 Airflow directed toward the windshield and side windows
- 3 Air for upper body area
The serrated dials in the center open and close through an infinitely-variable range to control air supply while also adjusting the air's direction like the lower serrated dials. You can find more information on adjusting for draft-free ventilation on page [107](#)
- 4 Air to footwell

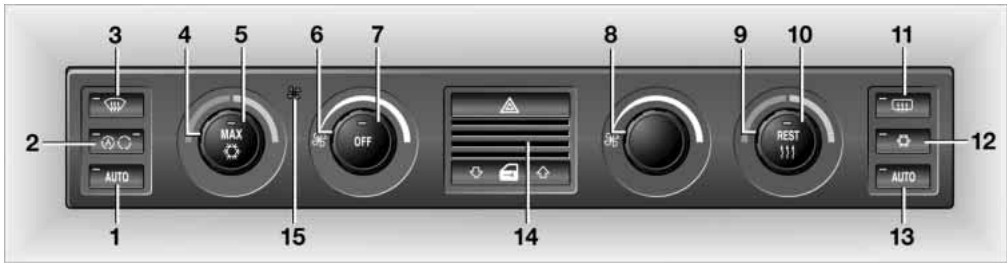

- 1 Automatic air distribution and supply, left side of passenger compartment 106
- 2 Outside air/AUC Automatic recirculated-air control/recirculated air 104
- 3 Defrosting windshield and windows and removing condensation 104
- 4 Temperature, left side of passenger compartment 104
- 5 Maximum cooling 104
- 6 Air supply, left side of passenger compartment 104
- 7 Switching off automatic climate control 106
- 8 Air supply, right side of passenger compartment 104
- 9 Temperature, right side of passenger compartment 104
- 10 Residual heat mode 105
- 11 Rear window defroster

- 12 Switching air conditioner mode on and off manually 104
- 13 Automatic air distribution and supply, right side of passenger compartment 106
- 14 Air grill for interior temperature sensor – please keep clear and unobstructed
- 15 Independent ventilation 109

- ▷ Activation time activated: The indicator lamp ☼ comes on
- ▷ Independent ventilation switched on: The indicator lamp ☼ flashes

▶ All other setting options for the automatic climate control can be found at "Settings" using the Control Center, refer to page 106. The current settings for temperature and air supply are displayed to you in the status line of the Control Display. A description of the Control Center is provided on page 17. ◀

A congenial climate

Activate the automatic mode using the AUTO button or "AUTO" in the Control Center, refer to page 106. Select an interior temperature you find pleasant.

The following section contains more detailed information on the available setting options.

▶ All of the air conditioner functions, including Maximum cooling, refer to page 104, and the Rear air conditioner, refer to page 108, are available only when the engine is running. ◀

 Your vehicle has been designed to automatically select your personal climate-control settings whenever you unlock the doors using your individually programmed remote control. ◀

Automatic air distribution and supply

 The AUTO program adjusts the airflow and distribution patterns for you while also using your preselected temperature setting as the basis for adjusting the interior climate to adapt to external influences: summer, winter.

The air conditioner comes on automatically when you select the AUTO program.

Temperature adjustment



You can turn to select the desired temperatures for the driver and passenger sides. Your settings appear on the Control Display's status line.

The figures in the display provide a general indication of interior temperature. When you start the vehicle, this system ensures that the selected temperature is achieved as quickly as possible. It then maintains this temperature, regardless of the season.

Defrosting windows and removing condensation



This program quickly removes ice and condensation from the windshield and door windows.

Adjusting air supply manually



You can adjust the air supply by turning. The automatic air supply control is operational whenever you see your selection represented by a bar on the

Control Display's status line. The automatic air distribution remains in operation as before. You can reactivate the automatic air supply mode with the AUTO button.

Switching air conditioner mode on and off manually



The air conditioner cools and dehumidifies the incoming air before also reheating it as

required, according to temperature setting. Depending on the weather, the windshield may fog over briefly when the engine is started.

The air conditioner comes on automatically when you select the AUTO program.

Maximum cooling



This program quickly provides maximum cooling.

The temperature display reverts to 60 °F/16 °C while the system switches to the recirculated-air mode and starts to provide maximum air supply through the vent outlets only. For this reason you should ensure that these outlets are open before selecting this program.

Outside air/AUC Automatic recirculated-air control/ recirculated air



You can respond to unpleasant odors or pollutants in the immediate environment by temporarily suspending the supply of outside air.

The system then recirculates the air currently within the vehicle. AUC executes this function automatically.

Press the button repeatedly to run through the following control sequence:

- ▷ Indicator lamps off: outside air flows into the vehicle
- ▷ Left indicator lamp on, AUC mode: the system detects pollutants in the outside air and responds by blocking the supply of outside air when required. The system then recirculates the air currently within the vehicle. Depending upon air quality, in the automatic mode the system may start to alternate between its outside-air and recirculated-air modes
- ▷ Right indicator lamp on, recirculated-air mode: the supply of outside air into the vehicle is permanently blocked. The system then recirculates the air currently within the vehicle.



If condensation starts to form on the inside window surfaces during operation in the recirculated-air mode, you should switch it off while also increasing air supply as required. ◀

Residual heat mode



The system uses the warmth stored in the engine to heat the interior when the ignition is off, for instance, while the vehicle is stopped at a school to pick

up a child.

You can adjust the automatic climate control's settings when the ignition lock is in the radio mode. The system blows heated air into the interior in accordance with the selected distribution pattern while the ignition is off.

▶ Provided that the engine has warmed to its normal operating temperature and the battery is charged, you can use this function for up to 15 minutes after switching off the ignition. The LED within the button lights up to confirm compliance with both of these conditions. ◀

Front ventilation

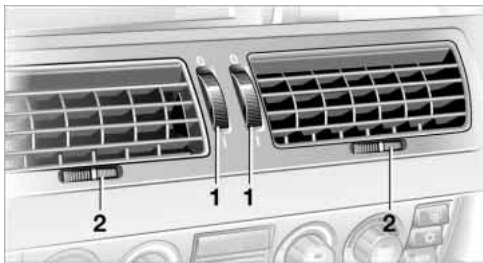

You can adjust the vent outlets for the upper body to suit your personal requirements.

You can use the serrated dials 1 to open and close the outlets through an infinitely-variable range, while the serrated dials 2 allow you to adjust the airflow direction.

Ventilation for cooling

Adjust the vents to direct the flow of cool air in your direction, for instance, if the interior has become too warm, etc.

Draft-free ventilation

Set the vent outlets so that the air flows past you and is not directed straight at you.

▶ You can also individually adjust the air temperature of the air vents for the upper body area in the Control Center, refer to page 107.

If the ventilation grill is completely closed, the vehicle interior is ventilated indirectly by air vents on the upper side of the cockpit. ◀

Ventilation for storage compartment in front armrest

You can use the serrated dial in the storage compartment to open and close the vent.

▶ Depending upon the temperatures selected at the rear dials, high temperatures may occur in the storage compartment. Close the vent as required. ◀

Ventilation in the rear



The serrated dials 1 allow you to open and close the ventilation outlets through an infinitely-variable range.

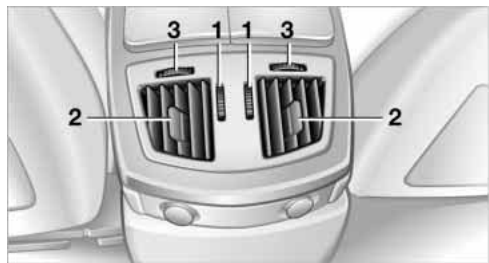

You can adjust the airflow direction using the levers 2.

The serrated dials 3* control the amount of cooled air in the flow from the vent outlets:

Turn towards blue: colder
Turn towards red: warmer.

This function allows you to make minor adjustments for maximum comfort while also letting you vary temperatures within the storage compartment.

Switching off automatic climate control*



The air supply, the heater and the air conditioner are all switched off. You can restart the automatic climate control by pressing any of its buttons except the REST button.

Settings using the Control Center

With the ignition on, select "Climate". You can use the Control Center to set the following:

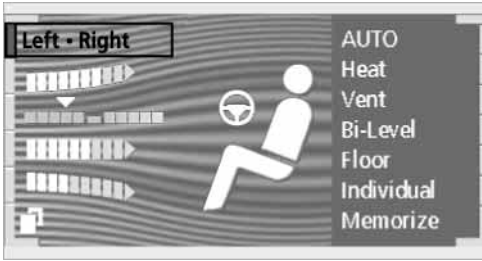

- ▷ "Left • Right": Separate settings for driver and front passenger
- ▷ Adjusting and adapting air-distribution patterns, refer to page 107
- ▷ Adjusting temperature for the upper body, refer to page 107
- ▷ Storing and calling up an individual setting for interior ventilation outlets, air distribution and temperature, refer to page 107.

☑ Select the second page of the "Climate" menu.

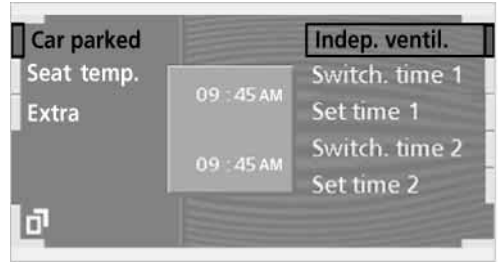

- ▷ "Indep. ventil.": For information on activating and deactivating the independent ventilation and setting the timer, refer to page 109
 - ▷ "Seat temp.": Adjusting temperature distribution while the seat heating is on, refer to page 50
 - ▷ "Extra": Switching the rear air conditioner or rear cooler on and off, refer to pages 108 and 113.
- ☑ Select the first page of the "Climate" menu.

Automatic air distribution and supply

"AUTO":

The AUTO program adjusts the airflow and distribution patterns for you while also using your preselected temperature setting as the basis for adjusting the interior climate to adapt to external influences: summer, winter.

"Bi-Level":

This program operates in the same way as the AUTO program, but with airflow directed toward upper body and into the footwells.

Combining the air distribution yourself

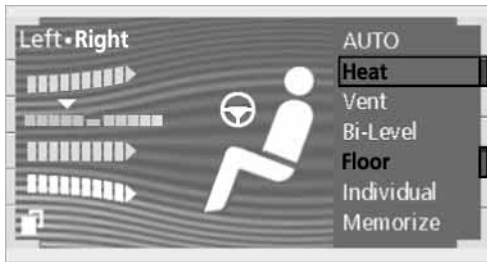

You can cancel the AUTO program by selecting specific air distribution patterns for your personal comfort.

Adjusting air distribution

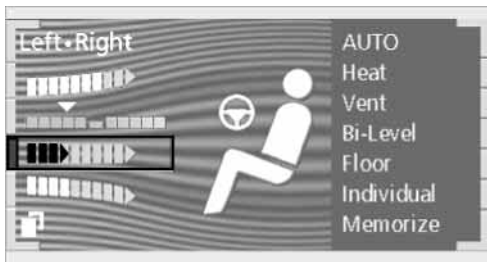

You also enjoy the option of adjusting the air distribution manually to obtain a climate that is ideally adapted to your personal requirements. The AUTO program is deactivated.

Select the desired symbol and confirm. Turn the controller to adjust the air distribution.

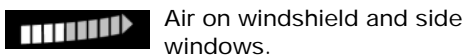

Air on windshield and side windows.

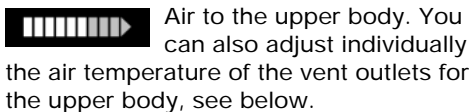

Air to the upper body. You can also adjust individually the air temperature of the vent outlets for the upper body, see below.



Air to footwell.

Adjusting temperature for the upper body

This function provides you with the option of making minor adjustments to achieve maximum comfort.

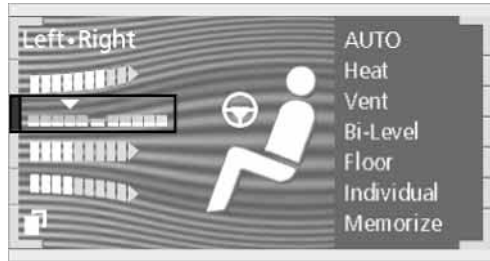

Use the temperature setting to adjust the amount of cool air that is added to the air-flow emerging from the vent outlets for the upper body. We recommend a moderate temperature setting, as cooler air helps promote fatigue-free driving.

Storing and calling up an individual setting

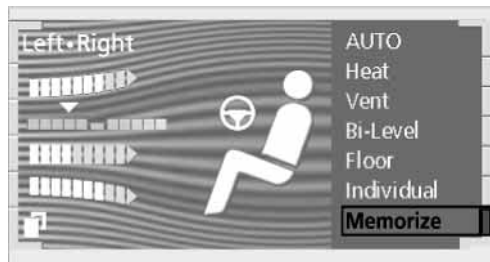

You can store your individual setting after adjusting the air distribution manually.

Select "Memorize" and confirm.

Now you can reselect the preset climate that precisely reflects your personal requirements.

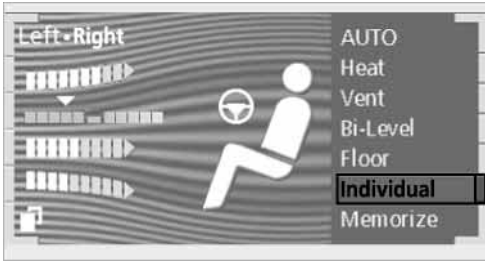

Select "Individual" and confirm. The AUTO program is deactivated.

Microfilter/activated-charcoal filter

The microfilter removes dust and pollen from the incoming air. The activated-charcoal filter provides additional protection by filtering gaseous pollutants from the outside air. Your BMW center replaces this combined filter as a standard part of your scheduled maintenance.

You can select a display of more detailed information in the Service Interval Display, refer to page 81.

Rear air conditioner*

The following settings and operating modes can be selected and adjusted separately on the left and right sides:

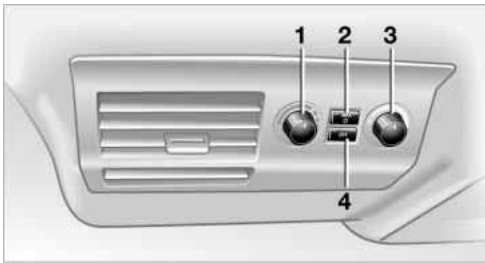

- 1 Adjusting cooling
- 2 Maximum cooling
- 3 Adjusting air supply manually
- 4 Switching off rear air conditioner

Switching on rear air conditioner

To switch on the rear air conditioner

- ▷ select maximum cooling 2
- ▷ press the OFF button 4 again
- ▷ in the Control Center, select "Rear air cond." and confirm, refer to Switching on/off using the Control Center.

▷ When you switch on the rear air conditioner, you simultaneously switch on the rear cooler, refer to page 113. ◀

Adjusting cooling



You can also set the system to provide the desired level of cooling by turning. We recommend setting the system for moderate cooling. When you start the vehicle, this system ensures that the selected setting is achieved as quickly as possible. It then maintains this temperature, regardless of the season.

Adjusting air supply manually



You can adjust the air supply by turning.

Maximum cooling



This program quickly provides maximum cooling.

The system automatically switches to the recirculated-air mode while a high-speed stream of air simultaneously emerges from the vent outlets. For this reason you should ensure that these outlets are open before selecting this program.

Switching off rear air conditioner





The air conditioner is switched off.

Press the button again to switch back on.

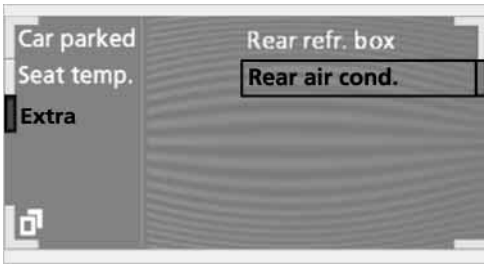
Switching on/off using the Control Center



1. With the ignition on, select "Climate"
2.  Select the second page of the "Climate" menu
3. Select "Extra" and confirm
4. Select "Rear air cond." and confirm.

 The maximum cooling mode is automatically activated when you switch on the rear air conditioner in the Control Center. ◀

Select "Rear air cond." again and confirm to switch off the system.

Rear ventilation

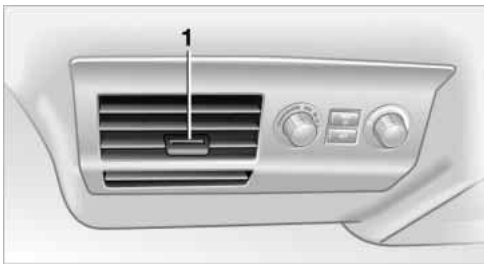

Use the lever **1** to vary the airflow direction. For additional information on rear ventilation options, refer to page [105](#).

Independent ventilation

System operation is controlled using the Control Center. You can set two different times for the system to start.

The independent ventilation blows air into the passenger compartment to lower interior temperatures.

The system remains on for 30 minutes. You can also switch the system on and off manually. Since the system uses a substantial amount of electrical current, you should refrain from activating it twice in succession without allowing the battery to be recharged in normal operation between use.

The independent ventilation is available for preprogrammed operation at outside temperatures above approx. 59 °F/15 °C and for direct activation at any temperature, but is not operational when the vehicle is underway.

The air enters the passenger compartment through the vent outlets in the instrument panel, which can be adjusted for both direction and airflow. These outlets must be open for the system to operate.

Switching on and off directly

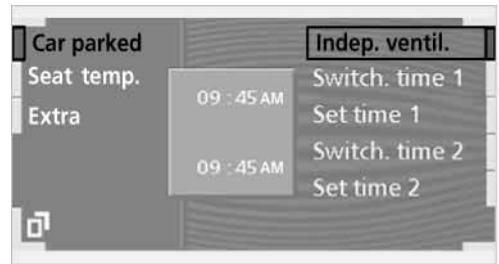

1. Switch on the radio mode
2. Select "Indep. ventil." on the second page of the "Climate" menu and confirm.

Select "Indep. ventil." a second time and confirm to deactivate the system manually.

Preselecting the switch-on time

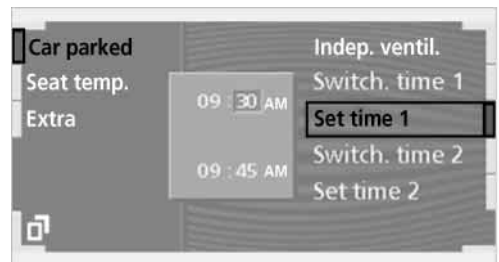

You can preselect two activation times.

1. Activate the radio mode at the ignition lock
2. Select "Indep. ventil." on the second page of the "Climate" menu
3. Select "Set time 1" or "Set time 2" and confirm
4. Enter the desired time
 - ▷ Turn: set
 - ▷ Press: confirm.

Activating the timer

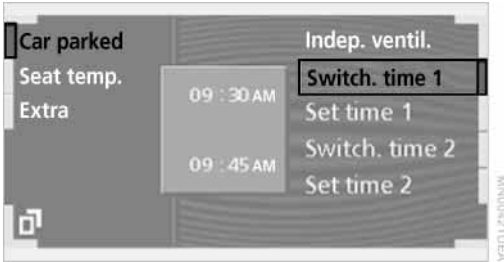

Select "Switch. time 1" or "Switch. time 2" and confirm.

- ▷ The independent ventilation is only available for activation within the subsequent 24 hours. After this, the time will have to be reconfirmed. ◀

Practical interior accessories

Integrated universal remote control*

The concept

The integrated universal remote control can replace as many as three hand-held transmitters for various remote-controlled accessories, such as door openers and house alarm systems. The integrated universal remote control registers and stores signals from the original hand-held transmitters.

The signal of an original hand-held transmitter can be programmed on one of the three memory buttons **1**. Following that, each of the devices can be actuated with the appropriately-programmed memory button **1**. The indicator lamp **2** flashes to confirm transmission of the signal.

If the vehicle is sold, the memory buttons **1** should be cleared as described on page [112](#).

 To prevent possible damage or injury, before programming or using the integrated universal remote control, always inspect the immediate area to make certain that no people, animals or objects are within the travel range of the device. Also, comply with the safety precautions of the original hand-held transmitter. ◀

Checking the compatibility

 If you see this symbol on the packaging or in the manual supplied with the original hand-held transmitter, it is safe to assume that it is compatible with the integrated universal remote control.

 If you have additional questions, please consult your BMW center or call 1-800-355-3515.

You can also visit these websites:

www.bmwusa.com or

www.homelink.com.

HomeLink is a registered trademark owned by Johnson Controls, Inc. ◀

Programming

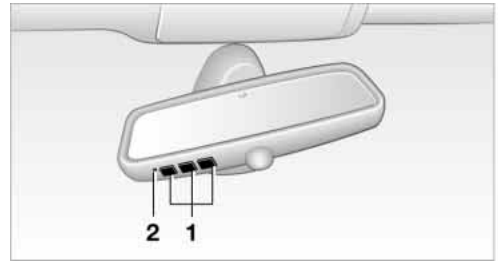

- 1 Memory buttons
- 2 Indicator lamp

Fixed-code hand-held transmitter

1. Switch on the ignition
2. When using for the first time: press both outer buttons **1** for approx. 20 seconds, maintaining pressure until the indicator lamp **2** starts to flash. The three memory buttons **1** are cleared
3. Hold the original hand-held transmitter at a distance of approx. 2 in/5 cm to 8 in/20 cm from the memory buttons **1**



The required distance between the hand-held transmitter and memory buttons **1** depends on the relevant system of the original hand-held transmitter used. ◀

4. Simultaneously press the transmit button on the original hand-held transmitter and the desired memory button **1** of the integrated universal remote control. Initially, the indicator lamp **2** flashes slowly. Release both buttons as soon as the indicator lamp **2** flashes rapidly. If the indicator lamp **2** does not flash rapidly after approx. 15 seconds, change the distance
5. To program other original hand-held transmitters, repeat steps 3 and 4.

The corresponding memory button **1** is now programmed with the signal of the original hand-held transmitter.

The device can be operated as of ignition on.

▶ If the device cannot be operated after repeated programming, check whether the original hand-held transmitter uses an alternating-code system. To do so, either read the instructions of the original hand-held transmitter or press and hold down the programmed memory button 1 of the integrated universal remote control. If the indicator lamp 2 on the integrated universal remote control flashes quickly for a brief period and then remains lit up for approx. two seconds, this indicates that the original hand-held transmitter is equipped with an alternating-code system. In the case of an alternating-code system, program the memory buttons 1 as described at the section on alternating-code transmitters. ◀

Alternating-code transmitters

Consult the operating instructions of the unit you wish to set when programming the integrated universal remote control. You will find information there on the possibilities for synchronization. When programming hand-held transmitters that employ an alternating code, please observe the following supplementary instructions:

▶ Programming will be easier with the aid of a second person. ◀

1. Park your vehicle within the range of the remote-controlled device
2. Program the integrated universal remote control as described at the section on fixed-code hand-held transmitters
3. Localize the button on the receiver of the device you want to set up, e.g. on the upper section of the motor
4. Press the button on the receiver of the device you want to set up. After step 4, you have approx. 30 seconds for step 5
5. Press the programmed memory button 1 on the integrated universal remote control three times.

The corresponding memory button 1 is now programmed with the signal of the original hand-held transmitter.

▶ If you have any additional questions, please contact your BMW center. ◀

Clearing memory buttons

Individual memory buttons 1 can not be cleared. However, you clear all three memory buttons 1 together as follows:

Press both outer buttons 1 of the integrated universal remote control for approx. 20 seconds, maintaining pressure until the indicator lamp 2 starts to flash.

Roller sun blinds*

Roller sun blind for rear window



To actuate from the radio position, briefly press the button in the driver's door.

Roller sun blinds for rear side windows

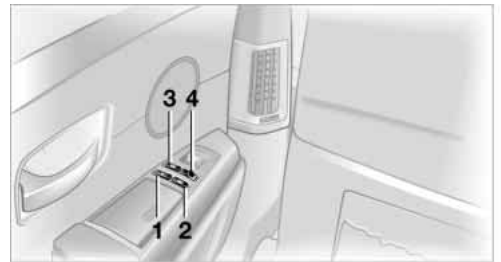

Activate by briefly pressing the desired button with the ignition lock in the radio mode.

- 1 Quarter window blind
- 2 Side window blind

- 3 Rear window blind
- 4 Switching to the other side

 The side window blind cannot be extended unless the side window is closed. If the window is open, the blind will rise slightly prior to immediately retracting to its original position. ◀

 Briefly press the safety switch in the driver's door, refer to page 42. The indicator lamp must light up. This precaution prevents children from operating the sun blinds using the rear switches, etc. Before using always ensure that the sun blind's travel path is clear and unobstructed.

When leaving the vehicle, always remove the remote control from the ignition lock and close the doors; this precaution prevents children from using the sun blinds and injuring themselves, etc. ◀

Automatically extending and retracting the sun blinds

You can extend and retract the sun blinds together by pressing and holding button 3 or the button in the driver's door.

Rear cooler*



The rear cooler is located behind the rear seats' center armrest.

Switching on/off

As of radio position, press the button, arrow 1; the indicator lamp in the button comes on.

 Vehicles with rear air conditioner: Once switched on, the rear cooler operates whenever the engine is running. High temperatures in the luggage compartment can affect the temperature in the rear cooler.

Vehicles without rear air conditioner: After the ignition has been switched off, the rear cooler is switched off automatically after a short period.

When a low voltage is reached, it is automatically switched off to protect the vehicle battery. The indicator lamp in the button flashes.

In the event of a malfunction, please contact your BMW center. ◀

Press the button, arrow 1, once again to switch off the rear cooler.

Opening

Press button and open cooler, arrow 2.

Switching on/off using the Control Center*

 When the rear air conditioner unit is switched on, the rear cooler operates whenever the engine is running. ◀

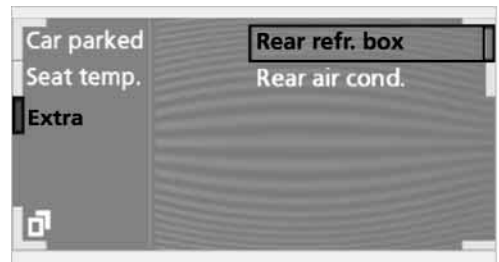

1. With the ignition on, select "Climate"
2.  Select the second page of the "Climate" menu
3. Select "Extra" and confirm
4. Select "Rear refr. box" and confirm.

Select "Rear refr. box" a second time and confirm to switch the unit off.

Glove compartment

Opening

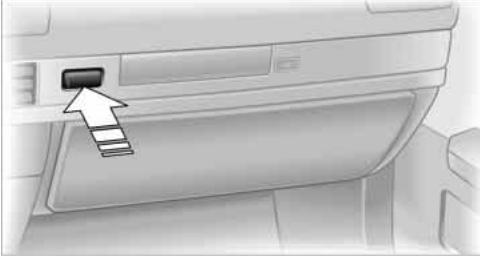

Press button. The glove compartment opens automatically and the lamps come on.

Closing

Fold the cover up.

⚠ To prevent injury in the event of an accident, close the glove compartment immediately after use. ◀

Rechargeable flashlight

The flashlight is located on the left side of the glove compartment. It features integral overload protection, so it can be left in its holder continuously.

⚠ Be sure that the flashlight is switched off when it is inserted into its holder. Failure to comply with this precaution could lead to overcharging and damage. ◀

Front center armrest

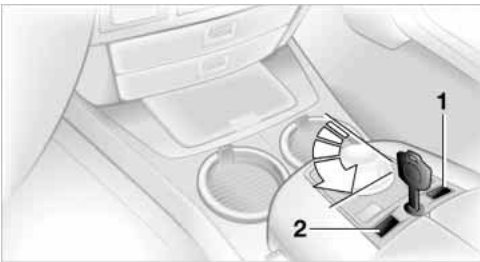

A storage compartment is located in the armrest between the front seats.

- 1 Open the right cover
- 2 Open the left cover

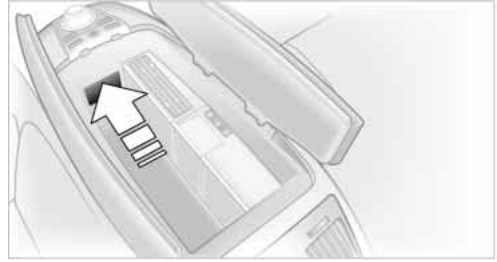

A removable coin holder is provided in the front of the compartment. Briefly press to open.

The mat within the compartment can be removed for cleaning.

Depending upon your model specification, any of the following may be located in the storage compartment:

- ▷ Removable CD holder*
- ▷ Fold-out and removable storage compartment*, e.g. for glasses or portable phone
- ▷ Fold-out and removable litter container*.

Locking storage compartment in the front armrest

You can use the key to lock the storage compartment in the armrest.

▷ You can lock the luggage compartment lid and the armrest storage compartment separately, refer to page 37, and then retain the key in your possession while handing over only the remote control when leaving the vehicle for valet parking etc., refer to page 32; this prevents unauthorized access to the luggage and front storage compartments. ◀

Ventilating storage compartment in the front armrest

You can use the serrated dial in the storage compartment to open and close the vent.

▷ Depending on the automatic climate control setting, the temperature

within the storage compartment may be higher than in the rest of the interior. Close the vent as required. ◀

Storage compartments

Glasses compartment



To open the compartment:
Briefly press the button.
You can remove the insert tray for cleaning.

Storage compartment in the center console



To open the compartment:
Briefly press the button.

Clothes hooks

 When suspending clothing from the hooks ensure that it will not obstruct the driver's vision. Do not hang heavy objects on the hooks. If you do so, they could cause personal injury during braking or evasive maneuvers. ◀

Beverage holders

Front



Below the sliding covers.

Rear



In the front of the rear seat cushion's center.

Briefly press to open; slide back to close.

Ashtray, front

Opening



Slide back the cover by the recess.

To extinguish a cigarette, tap off the ash and gently press the tip into the funnel.

Emptying

Press the button, refer to arrow 1. The ashtray rises for removal.

Cigarette lighter, front



Push down.

The lighter can be removed as soon as it jumps back out.

 Hold or touch the hot cigarette lighter by the knob only. Holding or touching it in other areas could result in burns. The cigarette lighter is also ready for operation when the remote control is unlocked. For this reason, do not leave unsupervised children in the vehicle. ◀

Lighter socket

The socket can be used to plug in hand lamps, car vacuum cleaners, etc., with power ratings of up to approx. 200 W at 12 V. Avoid damaging the socket due to inserting plugs of different shapes or sizes.

 With the ignition switched off, the power supply to all electrical sockets is cut off after approx. one hour. ◀

Power socket



An additional power socket is located in the front passenger's footwell.

To gain access, fold the cover cap up.

Ashtray, rear

Emptying



Press the cover entirely down. The ashtray rises for removal.

Cigarette lighter, rear

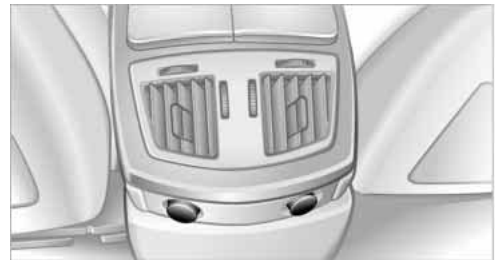

Refer to Cigarette lighter, front.

Rear center armrest

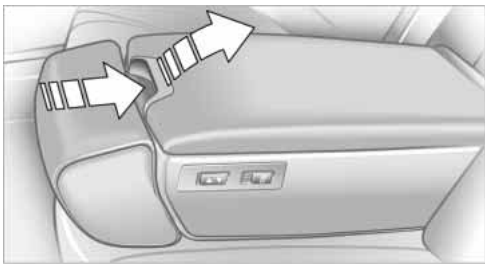

▶ Before folding down the armrest, adjust the head restraint to its lowest position, refer to page 48. ◀

To open the storage compartment: Press the button in the handle recess and fold up the cover.

Comfort seat in rear

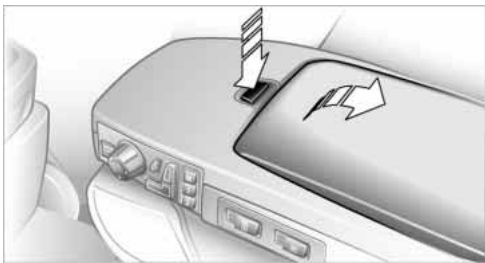

▶ Before folding down the armrest, adjust the head restraint to its lowest position, refer to page 48. ◀

To open the storage compartment: Press the button and fold up the cover.

Ski bag*

Designed for safe, convenient transport of up to four pairs of standard skis or up to two snowboards.

The ski bag itself plus the additional capacity provided by the luggage compartment make it possible to transport skis with a length of up to 6.9 ft/2.10 m. When skis of 6.9 ft/2.10 m in length are loaded the ski bag will tend to contract, reducing its overall capacity.

Loading

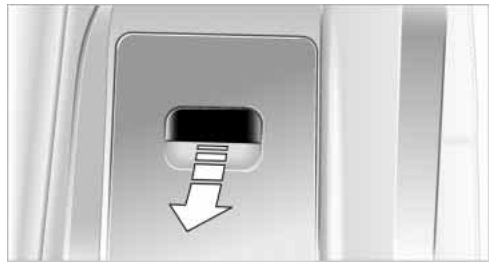

1. Lower the center armrest, open the cover and place it on the armrest



2. Remove the cover panel* and place it on the controller in the rear

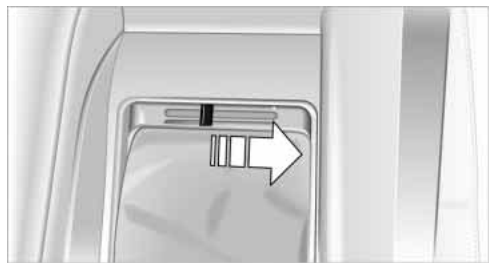

3. Open the hatch in the luggage compartment: Press the handle and slide it to the right
4. Extend the ski bag between the front seats. The zipper allows more convenient access to stored objects and can also be left open to allow the ski bag to dry.

Please ensure that the skis are clean before loading them into the bag. Take care to avoid damage from sharp edges.

Securing the load

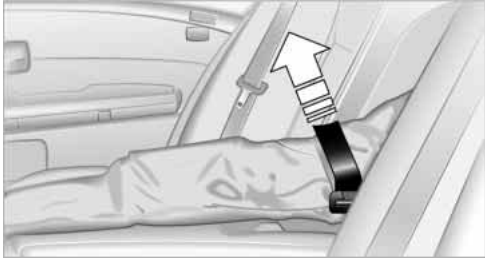

▶ Secure the bag's contents by tightening down the strap at the buckle. ◀

Stowing the ski bag

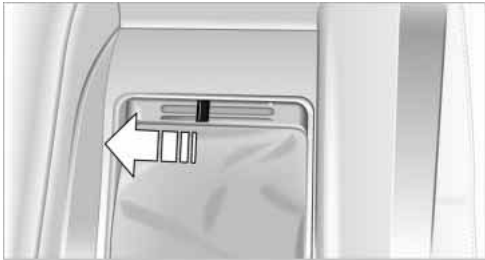

1. Close the hatch in the luggage compartment:
Press the handle and slide to the left
2. Fold up the ski bag and place it in the compartment



3. Engage the cover as shown
4. Close the cover.





Driving tips

This chapter is designed to provide you with extra support by supplying information useful in dealing with specific driving and operating conditions.

Things to remember when driving

Break-in procedures

To ensure that your vehicle continues to furnish optimized economy of operation throughout an extended service life, we request that you devote careful attention to the following section.

Engine and differential

Up to 1,200 miles/2,000 km:

During this initial period you should attempt to avoid constant, steady-state operation and vary both vehicle and engine speeds as often as possible. Until the break-in period has been completed you should also refrain from exceeding the following:

▷ 4,500 rpm or 105 mph/170 km/h.

Always obey all official speed limits.

Avoid full-throttle operation and use of the transmission's kickdown mode during these initial miles.

Once you have driven 1,200 miles/2,000 km, the engine or vehicle speeds can be gradually increased.

You should also comply with these break-in procedures should the engine or differential need to be replaced at a later point.

Tires

Due to technical factors associated with their manufacture, tires do not achieve their full traction potential until after an initial break-in period. Therefore, drive reservedly during the first 200 miles/300 km.

Brake system

Brakes require an initial break-in period of approx. 300 miles/500 km to achieve optimized contact and wear patterns between brake pads and rotors.

General driving notes

High temperatures

 Extreme temperatures occur at the catalytic converter on this and every catalyst-equipped vehicle. Do not remove the heat shields installed adjacent to various sections of the exhaust system, and never apply undercoating to them. When driving, standing at idle and while parking take care to avoid possible contact between the hot exhaust system and any highly flammable materials such as hay, leaves, grass, etc. Such contact could lead to a fire, accompanied by the risk of serious property damage as well as personal injury. ◀

Parking the vehicle

Condensation forms in the air conditioner system during operation, and then exits under the vehicle. Traces of condensed water under the vehicle are thus normal.

Before driving into the car wash

1. Fold in the exterior mirrors, refer to page 51, as otherwise they could be damaged due to the width of the vehicle
2. Leave the remote control in the ignition lock, as otherwise the position P of the automatic transmission will automatically be selected when the remote control is removed, refer to pages 61 and 67.
With Comfort Access, be sure to observe the instructions on page 61
3. Release the parking brake, especially when you have activated Automatic Hold, refer to pages 62 and 63.

Hydroplaning

 When driving on wet or slushy roads, reduce road speed. If you do not, a wedge of water can form between tires and road surface. This phenomenon is referred

to as hydroplaning, and is characterized by a partial or complete loss of contact between tires and road surface, ultimately undermining your ability to steer and brake the vehicle. ◀

Driving through water

 Do not drive through water on the road if it is deeper than 1 ft/30 cm, and then only at walking speed at the most. Otherwise, the vehicle's engine, the electrical systems and the transmission may be damaged. ◀

Brake system

Braking with ABS

The best way to achieve the best response from the ABS is to apply maximum pressure to the brake pedal – panic stop. Since the vehicle maintains steering responsiveness, you can nevertheless avoid possible obstacles with a minimum of steering effort.

Pulsation at the brake pedal combines with sounds from the hydraulic circuits to indicate to the driver that ABS is in its active mode.

 Do not drive with your foot resting on the brake pedal. Otherwise, even light but consistent pedal pressure can lead to high temperatures, brake wear and possibly even brake failure. ◀

Disc brakes

Driving in wet conditions

While driving in wet conditions and in heavy rain, it is a good idea to apply light pressure to the brake pedal every few miles. Monitor traffic conditions to ensure that this maneuver does not endanger other road users. The heat generated in this process helps dry the pads and rotors to ensure that full braking efficiency will then be available when you need it.

Hills

You can retain full and unimpaired braking efficiency by downshifting to a gear in which only minimal brake applications are needed when descending long or steep downhill stretches.

You can further enhance the engine's braking effect by selecting a lower gear in the automatic transmission's manual mode, downshifting as far as first gear on extremely steep stretches, refer to page 67. This strategy helps you avoid placing excessive loads on the brake system.

 Never allow the vehicle to coast with the transmission in Neutral – or with the engine switched off – as there is no engine braking when the transmission is in Neutral, and no power-assist for brakes and steering when the engine is not running.

Never allow floor mats, carpets or any other objects to protrude into the area around the accelerator and brake pedals and obstruct their movement. ◀

Corrosion

When the vehicle is driven only occasionally, during extended periods when the vehicle is not used at all, and in operating conditions where brake applications are less frequent, there is an increased tendency for corrosion to form on rotors, while contaminants accumulate on the brake pads. This occurs because the minimal pressure which must be exerted by the pads during brake applications to clean the rotors is not reached.

Should corrosion form on the brake rotors, the brakes will tend to respond with a pulsating effect that even extended application will fail to cure.

Brake pads

 If the brake pad wear warning lamp appears in the Check Control, accompanied by a text. Please take careful note of the additional information on the Control Display.



Warning lamp for Canadian models.

The brake pads have reached their minimum pad thickness. Have them replaced at your BMW center as soon as possible.



For your own safety: use only brake pads that BMW has released for your particular vehicle model. As BMW cannot assess the suitability of other brake pads for use on your vehicle, we are unable to assume continued responsibility for the vehicle's operating safety if non-approved pads are installed. ◀

Cargo loading



To avoid loading the tires beyond their approved carrying capacity, never overload the vehicle. Overloading can lead to overheating and increases the rate at which damage develops inside the tires. The ultimate result can assume the form of a sudden air loss. ◀

Determining loading limit



1. Locate the following statement on your vehicle's door pillar*:



The combined weight of occupants and cargo should never exceed XXX lbs. or YYY kg, as otherwise the vehicle may be damaged and unstable driving conditions may result. ◀

2. Determine the combined weight of the driver and passenger that will be riding in your vehicle

3. Subtract the combined weight of the driver and passenger from XXX lbs. or YYY kg
4. The resulting figure equals the available amount of cargo and luggage load capacity.
For example, if the XXX amount equals 1,400 lbs. and there will be five 150-pound passengers in your vehicle, the amount of available cargo and luggage load capacity is 650 lbs.:
1,400 lbs. minus 750 lbs. = 650 lbs.
5. Determine the combined weight of luggage and cargo being loaded on the vehicle. That weight should not exceed the available cargo and luggage load capacity calculated in step 4
6. If your vehicle will be towing a trailer, part of the load from your trailer will be transferred to your vehicle. Consult the manual for transporting a trailer to determine how this may reduce the available cargo and luggage load capacity of your vehicle.

Load

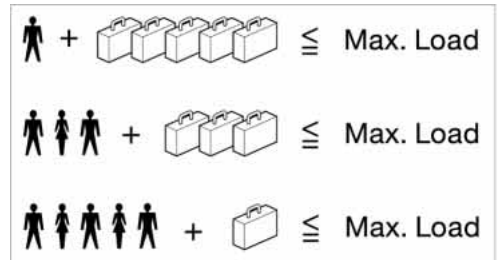

The permitted load is the total of the weight of occupants and cargo/luggage. The greater the weight of occupants, the less cargo/luggage can be transported.

Stowing cargo

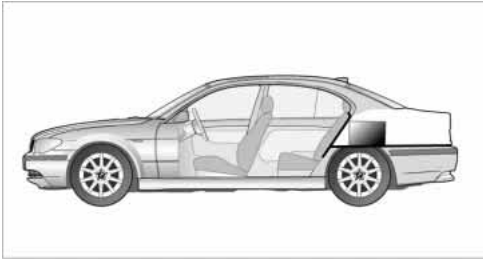

BMW00718231A

- ▷ Load heavy cargo as far forward and as low as possible, placing it directly behind the bulkhead behind the rear seats
- ▷ Cover sharp edges and corners
- ▷ For very heavy cargo when the rear seat is not occupied, secure each safety belt in the opposite buckle.

Securing cargo

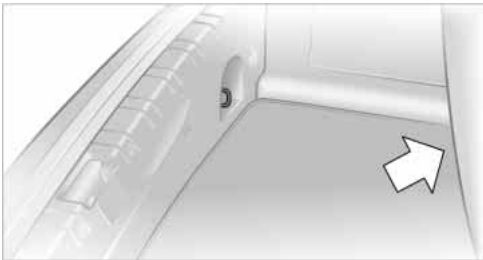

BMW00718231A

- ▷ Use the luggage net* or securing straps to hold down small and lightweight luggage and cargo, refer to page 39
- ▷ Heavy-duty cargo straps* for securing larger and heavier objects are available at your BMW center. Anchorages for attaching these heavy-duty straps have been provided in your vehicle's luggage compartment, refer to the illustration
- ▷ Please observe the special instructions supplied with the anchorage fittings.

 Always position and secure the load correctly. If you do not, it can even endanger the passengers during braking or evasive maneuvers.

Never exceed either the approved gross vehicle weight or either of the approved

axle loads, refer to page 214, as excessive loads can pose a safety hazard, and may also place you in violation of freeway safety laws.

You should never transport heavy or hard objects unsecured in the passenger compartment, as they could fly around and pose a safety hazard to the vehicle's occupants during abrupt braking or evasive maneuvers. ◀

Roof-mounted luggage rack*

Anchorage points

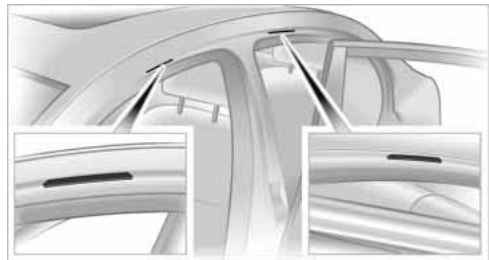

BMW0071811CH

The anchorage points are located within the door openings.

A special rack system is available as an option for your BMW. Please comply with the precautions included with the installation instructions.

Because roof racks raise the vehicle's center of gravity when loaded, they have a major effect on its handling and steering response.

You should therefore always remember not to exceed the approved roof weight, the approved gross vehicle weight or the axle loads when loading the rack.

You can find the specified weights in the Technical data section on page 214.

Make sure that the load is not too heavy, and that it does not extend outward to beyond the limits of the loading surface. Always load the heaviest pieces first – on the bottom. Be sure that adequate clearance is maintained for raising the glass roof, and that objects do not project into

the opening path of the luggage compartment lid.

Secure roof-mounted cargo correctly and securely to prevent it from shifting or being lost during the trip.

Drive smoothly. Avoid sudden acceleration and braking maneuvers. Take corners gently.

Entry/pass tags

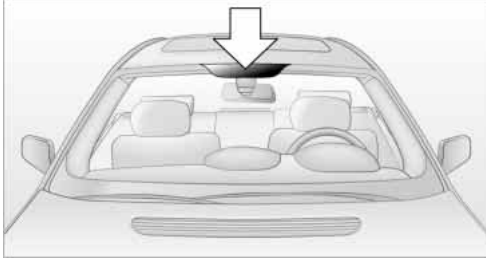

Infrared windshield technology has been used on your vehicle to minimize solar heating of the vehicle interior. This technology also reduces the ability of electronic devices to transmit and receive through the windshield, which will impair their performance and operating range.

If you want to place an electronic toll collection device or entry/pass tags behind the windshield, please use the area marked in the illustration. This area is clearly visible from inside the vehicle.

Standard holder*

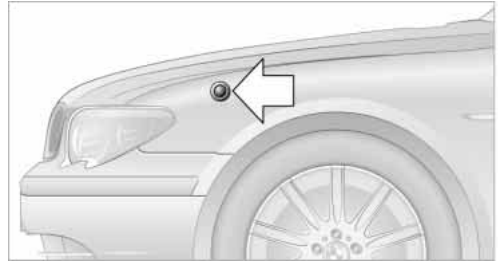

Remove the protective cap, insert the standard and lock in place by turning by 90°.

 At high speeds, remove the standard, as otherwise the standard, standard holder and vehicle can be damaged. ◀





Navigation

This section contains various examples that illustrate how the navigation system provides you with reliable guidance to your destination.

Starting the navigation system*

GPS

 Enter data only when the vehicle is stationary, and always obey the traffic regulations and road signs in the event of any contradiction between traffic and road conditions and the instructions issued by the navigation system. If you do not observe this precaution, you may be in violation of the law, and can endanger vehicle occupants and other road users. ◀

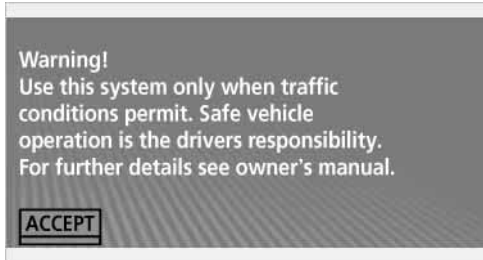

GPS stands for Global Positioning System. This integral component within your vehicle's navigation system relies on reference satellites to determine the precise position of your vehicle.

By allowing you to find your destination without having to consult conventional road maps as you drive, the navigation system makes an important contribution to traffic safety.

The result: the navigation system provides you with dependable guidance to your destination.

Navigation CD/DVD

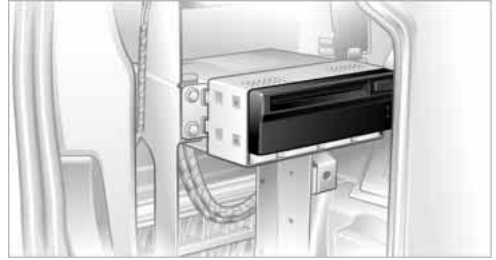

Navigation CDs/DVDs are inserted in the navigation computer located behind the left side trim in the luggage compartment.

You can use navigation CDs as of 2001-1 and navigation DVDs in your navigation computer.

To ensure that your vehicle's navigation system has access to the latest highway network information, always load the most recent CD/DVD version of the digital road map.

As is the case with conventional road maps, the navigation CDs/DVDs are subject to periodic updates to ensure that they reflect the latest information and surveys.

 Navigation CDs/DVDs are available at your BMW center. ◀

Changing navigation CDs/DVDs

As you drive your BMW, the computer will alert you when you are leaving the area stored on your current navigation CD/DVD; you should respond by changing the navigation CD/DVD in the navigation computer.

Navigation CDs contain road maps covering one or more countries or regions.

Roadmaps of Europe are stored on the navigation DVD.

To change the navigation CD/DVD:

1. Press the button



The CD/DVD is ejected from the navigation computer

2. Remove the CD/DVD
3. Insert the new CD/DVD with the labeled side up.

Allow approx. eight seconds for the system to scan the data from the new CD/DVD.

Opening the navigation

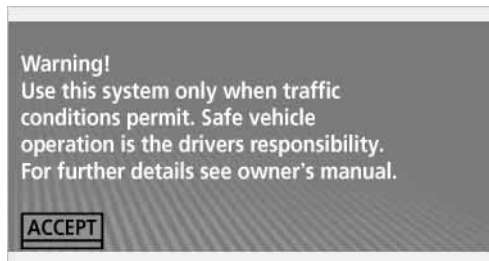

Select "Navigation".

The last selected view appears on the Control Display. This display will be continually updated as you drive.

When you park the vehicle before reaching the entered destination, upon restarting you will see the question "Continue route guidance?" on the Control Display.

- ▷ When you enter "YES", the destination guidance resumes active operation and the last selected screen content appears on the Control Display
- ▷ When you enter "NO" the Control Display returns to the destination entry mode.

Overview

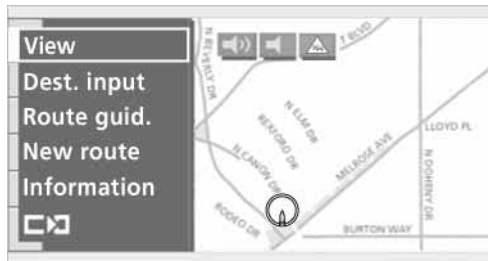

Press the controller to view the menu items.

- ▷ In the map display mode and during destination guidance, all the menu items will disappear after a few moments if no further entries are made. ◀

Display in assistance window*

You can also view the destination guidance in the assistance window; it then remains visible when you select a new menu.

Select  and confirm.

The assistance window displays the view selected on the Control Display. This can be:

- ▷ Map direction north
- ▷ Map in travel direction
- ▷ Map perspective
- ▷ Arrow display.

The contents of the assistance window are continually updated as you drive.

To deactivate display:

Select  again and confirm.

Destination entry

In entering your destination you can select from among the following options:

- ▷ Manual entry of destination address, see below
- ▷ Selecting the town or city and the street from the directory, refer to page 134
- ▷ Selecting the map-guided destination, refer to page 134
- ▷ Selecting destination in Information, refer to page 135
- ▷ Selecting from among recent destinations, refer to page 136
- ▷ Selecting destination from address book, refer to page 142.

After selecting your destination you can proceed to start the destination guidance, refer to page 139.



Enter data only when the vehicle is stationary, and always obey the traffic regulations and road signs in the event of any contradiction between traffic and road conditions and the instructions issued by the navigation system. If you do not observe this precaution, you may be in violation of the law, and can endanger vehicle occupants and other road users. ◀

Manual entry of destination address

1. Press the controller
2. Select "Dest. input" and confirm

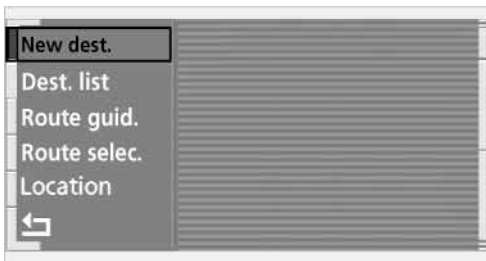

3. Select "New dest." and confirm.

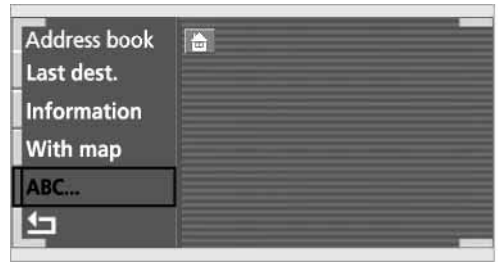

These menu items offer you various options for entering your destination, as described in the following section.

The system relies on a wordmatch principle to make it easier for you to enter the names or towns or streets. It supports various spellings as well as automatic name completion, refer to page 138.

You can enter the address of your destination with "ABC...".

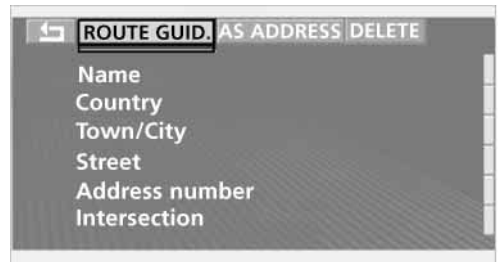

- ▷ "ROUTE GUID." is used to select the entered address as destination and to start destination guidance
 - ▷ "AS ADDRESS" can be used to store the entered address in the address book.
- You can store approx. 50 addresses and then import them directly from your address book to the navigation system as travel destinations, refer to page 142
- ▷ "DELETE" deletes the entered address.

The following features must be borne in mind for destination entry:

- ▷ If you do not enter a street, the system will guide you as far as the city limits
- ▷ Depending on the data stored on your navigation CD/DVD, you can also enter the house or building number on some streets
- ▷ You can skip the entry of country and locality if the current entries are being retained for your new destination
- ▷ You can overwrite street names if you would like to proceed to another street within the same locality.

The example shows how to use the navigation system to find the following destination:

United States
Beverly Hills, Ca
455 N Rexford Drive

To enter the destination address:
Select "ABC..." and confirm.

Entering name

The name is not required for the destination guidance or storage in the list, however can simplify the assignment of addresses.

1. Select "Name" and confirm



2. Turn to select the letters, then confirm by pressing.

Special characters:

 - Cancel selection process
 - Enter blank
 - Delete last letter
3. Select the name shown in the lower half of the Control Display and confirm.

Selecting country of destination

When the name of a country appears in white letters on the Control Display, this indicates that data for more than one country is stored on the navigation CD.

To select the United States as your country of destination:

1. Select "Country" or the country named in the display and confirm. A list of available countries appears in the display
2. Turn until "United States" is selected
3. Press to apply your selection as your destination entry.

Entering destination

"Town/City" or the name of the locality of your last destination will now appear.

1. Select "Town/City" or the displayed town name and confirm



2. Turn until "B" is selected
3. Press to confirm.

A directory listing localities starting with the letter "B" appears in the lower half of the Control Display. The list grows smaller each time you enter a new letter
4. Enter "Beverly Hills" by selecting and confirming the letters individually.

Special characters:

 - Cancel selection process
 - Enter blank
 - Delete last letter
5. Select name of locality from the directory and confirm.



A town or city must be entered before destination guidance can start. ◀

Entering street, house number and intersection

"Street" or the name of the last street entered will appear.



For instructions on entry, refer to Entering destination.

After entering the street you can proceed to select the house number, for instance: "455".

1. Turn until "4" is selected
2. Press to confirm.

Use the same procedure to select all of the remaining digits in the house number.

Special characters:

Cancel selection process

Enter blank

Delete last digit

3. Select the number that appears in the lower half of the Control Display and confirm



If the selected house number is not stored on the navigation CD/DVD, the system will apply the nearest available number.

The option for entering house numbers will not be offered if no house numbers are stored for the selected street on your navigation CD/DVD. ◀

4. Address

▷ "ROUTE GUID." is used to select the entered address as destination and to start destination guidance

▷ The "AS ADDRESS" command can be used to store the entered address in the address book.

The procedure for entering intersections is basically the same as that used for streets.

Selecting the town or city and the street from the directory

If you are uncertain about the precise name of the city or town, or the street, the directory can assist you in entering this information. It can show you all of the stored localities in a given country or of the streets listed for any particular town or city.

The directory appears as soon as you enter the first letter of a locality or street. You obtain a more selective listing the more letters you enter.

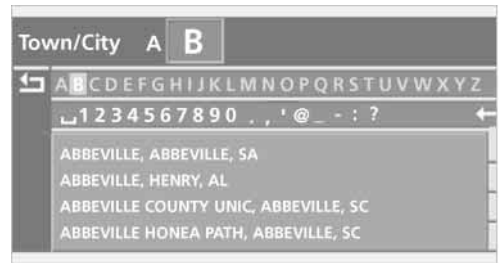

Selecting the destination from the map

Assume that you only know the general location of your destination's street or locality. You also have the option of selecting the destination on a map using a target cursor and importing it into the destination guidance.

1. Select "With map" and confirm



On the Control Display, a map section is displayed around the first destination from the destination list, even if the destination guidance is switched off. ◀

2. Turn the controller to adjust the scale

3. Move the controller in the desired direction to localize your destination. If no further changes are made to the map, after a brief pause the name of the street or locality marked by the cursor will appear on the screen
4. Press the controller to view other menu items:



- ▷ closes "With map"
- ▷ "Next" changes back to "With map"
- ▷ "Location" selects the current position as the map's focus again
- ▷ With "Save dest.", the address in the target cursor can be applied into the destination entry using "ROUTE GUID." or stored in the address book with "AS ADDRESS". If the navigation system is unable to identify a street or town/city, your current map coordinates will appear. In order to be able to select this position as destination or to store it in the address book as an address, a name must first be entered, refer to "ABC..."

You can also use the destination entry map without entering a town or city if you wish to select a destination and import it using the target cursor. ◀

Selecting destination in Information

Assume that you are searching for a particular place within a town or city, such as a hotel or restaurant, a filling station, the nearest BMW center, tourist attractions, a hospital.

1. Select "Information" and confirm



2. Select "On location" and confirm
3. Select the desired type of destination, such as "Hotels" and confirm
4. A maximum of ten destinations now appears on the right side of the Control Display. These are listed by distance to destination, while arrows also appear to indicate their directions from your current position
5. Select and confirm the destination
6. Selecting the address transfers it to the destination list
 - ▷ the view can be shifted upwards or downwards
 - ▷ the view can be closed and a change is made back to "ABC..."

Using the voice command system:

1. ›Navigation‹
2. ›Information location‹
3. Enter the desired type of destination:
 - ▷ ›Hotels‹
 - ▷ ›Parking‹
 - ▷ ›Gas stations‹.

Looking for interesting destinations

Are you looking for an interesting destination in a specific locality or country? You can obtain an overview from the navigation CD/DVD which contains listings of interesting destinations in various categories.

1. Select "Information" and confirm

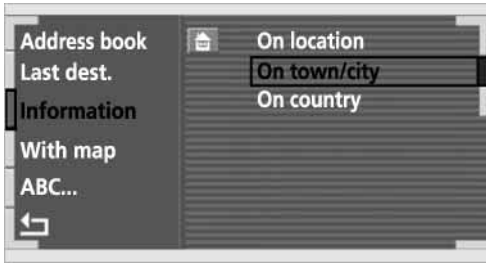

2. Select "On town/city" or "On country" and confirm. A screen for entering the town/city appears on the Control Display
3. Enter the desired town/city or country, select "Next" and confirm
4. Select your destination category, such as "Airport" and confirm. "ABC..." appears on the Control Display screen along with an alphabetical listing containing all entries in the selected destination category. You can obtain a more selective display of the information contained in the directory by entering one or more letters
5. Select the desired entry.

Using the voice command system:

1. ›Navigation‹
2. ›Information destination‹
3. Enter the desired type of destination:
 - ▷ ›Hotels‹
 - ▷ ›Parking‹
 - ▷ ›Gas stations‹.

Recent destinations

Returning to a recent destination

The system stores the last ten destinations entered.

Select "Last dest." and confirm.

A list of the stored addresses appears on the right side of the Control Display.

Confirm the desired destination and apply it into the destination entry with "AS DEST.". You can also edit existing entries; for conditions refer to "ABC...".

- ▷ "AS ADDRESS" stores the destination address in the address book
- ▷ "DELETE" removes the destination address.

To delete all current entries:

Select  and confirm.

Destination list

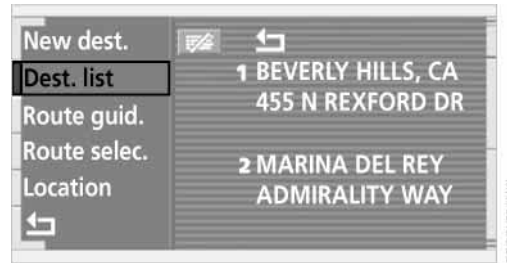

This is the most current listing of entered destinations, with the most recent destinations at the top of the list.

 Once you have reached the top destination, you are moved on to the next entry in the destination list. ◀

You can edit the entries in this list; start by selecting an entry.



- ▷ Edit using "CHANGE"; for conditions, refer to "ABC...". In this case, the entries are stored with "AS ADDRESS" in the address book and with "ACCEPT" applied into the destination list

- ▷ Use "DELETE" to remove an entry
- ▷ Use  to move the address into the destination list. This can change the order of the destination list.

To delete all current entries:

Select  and confirm.

Route selection

The navigation system also provides you with the option of selecting a specific travel route. You can define criteria for determining your individual route.

1. Select "Route selec." and confirm:

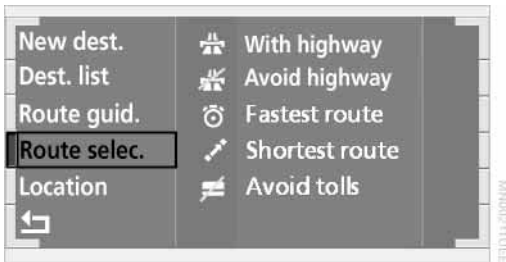

Various options are now listed on the right side of the Control Display

2. Select the priorities for your travel route and confirm:

- ▷ "With highway"

Freeways and major traffic arteries receive top priority

- ▷ "Avoid highway"

Freeways are avoided where possible

- ▷ "Fastest route"

The system determines the fastest route; the selection criteria are distance, vehicle speed and potential sources of traffic congestion

- ▷ "Shortest route"

Shortest travel distance, determined without including time as a selection criterion

- ▷ "Avoid tolls"

The system avoids tollways whenever possible in selecting the route.

You can change the selected route as often as you like, both when entering your destination and at any time while the system is guiding you to it – the system revises its travel recommendations accordingly.



The navigation system relies on specific rules to determine your route.

These vary according to the different kinds of roads stored on the map CD/DVD. As a result, the routes recommended by the navigation system may not always be the same ones that you would choose based on personal experience. ◀

Using the voice command system:



1. ›Navigation‹
2. ›Route selection‹
3. Enter the desired priority for your travel route:
 - ▷ ›Via freeway‹
 - ▷ ›Without freeway‹
 - ▷ ›Fastest route‹
 - ▷ ›Shortest route‹

Wordmatch principle

The system relies on a wordmatch principle to make it easier for you to enter the names of towns or streets. The system runs ongoing checks, comparing your destination entries with the data stored on the navigation CD/DVD as the basis for instant response. The user benefits include:

- ▷ When you make an entry that consists of more than one word, the system can identify the name regardless of the sequence in which you enter the individual words.

Example:

Official version:

J.F. Kennedy Square

Possible entries:

Kennedy Square J.F.

or:

Square J.F. Kennedy

- ▷ Names of specific locations can also vary from the official versions provided that the spelling of the entry corresponds to a standard form used in another country
- ▷ When you are entering the names of towns and streets the system will complete them automatically as soon as enough letters are available to ensure unambiguous identification.

Example:

If you want to drive to Iowa Ave NW in Washington, the system has already identified the street name when "o" is entered and displayed it in the lower half of the Control Display

- ▷ The system only accepts name entries beginning with letters that are stored on the navigation CD/DVD. The system will not accept nonexistent names and addresses.

Destination guidance

Starting the destination guidance

Select "Route guid." and confirm.

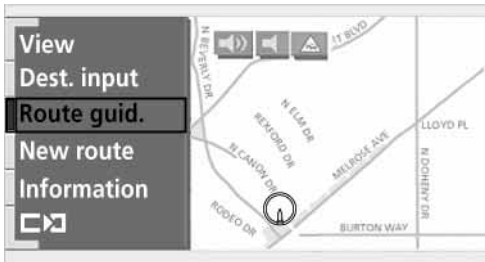

As the navigation computer determines the route to your destination, the distance and the true compass direction to your destination will appear at the upper right of the Control Display – not in all display modes.

Once the system has determined your travel route, the city or town of destination will appear in the upper right corner of the display. The destination guidance is carried out in dependence on the selected view, refer to Displaying route.

The system also provides you with voice instructions.

 You are also guided to your destination if you select another menu, e.g. "Entertainment" or "Climate". You are informed of a required change in direction by means of spoken announcements in good time prior to every intersection. ◀

 ›Route guidance on◁.

Displaying route

The "View" menu allows you to view your current travel route at various resolutions.



Displaying route map

You can also select a map showing your travel route while the system is guiding you to your destination.

1. Select "View" and confirm. All the menu items will disappear after a few moments if no further entries are made
2. Select the view and confirm:
 - ▷ "Map facing N"
A map facing north appears
 - ▷ "Map dir. travel"
A map facing the direction of travel appears
 - ▷ "Perspective"
A map with the planned route from a 'bird's eye' view appears
 - ▷ "Arrow display"
The destination guidance is by means of arrows on the Control Display and in the Info Display
 - ▷ "Route"
The planned route appears as a list.

 During destination guidance, the route map "Map facing N" will appear automatically when you enter an area that is not completely covered by your navigation CD/DVD. ◀

 ›Map◁
Shows the navigation system map.

Changing scale

Turn the controller to adjust the scale. The map scale is provided at the lower right of the Control Display.

1.  Scale
2. Enter the desired map scale.

Altering display direction

1. Select "View" and confirm. All the menu items will disappear after a few moments if no further entries are made
2. Select "Map dir. travel" or "Map facing N." and confirm.

Canceling route map

To change to directional arrow mode:

1. Select "View" and confirm. All the menu items will disappear after a few moments if no further entries are made
2. "Arrow display"
The destination guidance is by means of arrows on the Control Display and in the Info Display, refer to page 12.

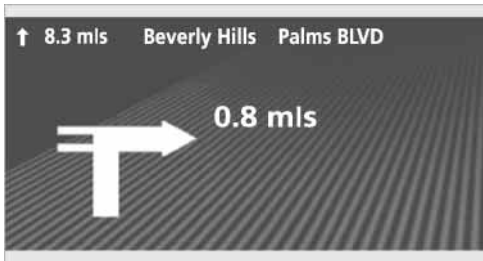

 The arrow will follow the general course when you travel through an area for which your navigation CD/DVD does not provide comprehensive coverage. This feature is intended to assist you at crossroads and intersections. ◀

Displaying route list

You can access a listing of streets and towns on your route whenever the destination guidance is active. This list is based on the navigation system's suggested travel route.

The distances remaining to be traveled on each individual road are also displayed.

1. Select "View" and confirm. All the menu items will disappear after a few moments if no further entries are made
2. Select "Route" and confirm. If the system has not yet completely defined the travel route, "..." will appear in the list.

Select  and confirm to switch off the route list.

 The route list is displayed again after a short time if no other menu item has been selected. ◀

Selecting new route

During destination guidance you can revise the navigation system's route recommendations to avoid particular stretches of road. Enter the number of miles/kilometers that you want to travel before returning to the original route.

Select "New route" and confirm.



- ▶ "Avoid sect.":
The route list appears on the Control Display. Select one or several connected sections of the route that you wish to avoid and confirm. You can correct erroneous entries by again selecting and confirming the stretch of the travel route to cancel its avoid status. You can also replace the avoid section by marking another stretch.
Select  and confirm; the route list is closed and a new route is calculated

- ▷ "Avoid route":
You can also make a detour of up to 20 miles/30 km around selected sections of the calculated route. Proceed by turning the controller to enter the desired detour mileage, then confirm. To exit the "Avoid route" mode without modifying your route, enter 0 miles/0 km and confirm your entry.

Bypassing traffic congestion

If traffic congestion is present on your projected travel route, the navigation system will issue a "Last exit" warning just before you reach the back-up.

To obtain an alternative route leading around the traffic congestion:

Select  and confirm

or

1. Select "New route" and confirm
2. Select "Detour" and confirm.

The GPS navigation system determines a new route and then returns to the destination guidance.

 The traffic information service might not be available in some regions, which means that a traffic congestion cannot be displayed. ◀

Selecting the destination

At "Information", you can select the corresponding destinations. For details, refer to Selecting destination in Information, page 135 and Looking for interesting destinations, page 135.

Voice guidance

To prevent the navigation system from interrupting other audio sources, such as a news program or traffic bulletin, you can deactivate the voice guidance system.

Press the controller and select the desired symbol during destination guidance:

◀ To activate and deactivate voice guidance.

 ›Message on◁ or
›Message off◁.

◀ To repeat most recent instructions with information on route or travel direction, when the voice guidance is activated.

Volume adjustment

You can adjust the volume for the navigation instructions:



Wait until the voice guidance is issuing instructions, then turn the button to select the desired volume.

The navigation system's voice guidance will continue to issue instructions at this volume level, even if the other audio sources are set to minimum volume.

 The system automatically selects your individual volume setting each time you unlock the vehicle using your personal remote control. ◀

Terminating/interrupting destination guidance

Select "Route guid." and confirm.

The system suspends destination guidance, including voice guidance, until reactivated.

 1. ›Navigation◁
2. ›Route guidance off◁.

Address book

To make it even easier to enter destinations, the system lets you store addresses for frequent destinations.

You have the possibility to store the addresses in two separate address books:

- ▷ The address book of the navigation system
- ▷ The address book of the voice command system.

Navigation system address book

Storing addresses

In this address book, you can store approx. 50 addresses.

Addresses can be entered from different menus.

The system stores the current address in the address book with "AS ADDRESS".

 You can also enter your current position in the address book after leaving the sector covered by the navigation CD/DVD. In this case, you must enter a name. ◀

Selecting an address

Select "Address book" and confirm.



A list of the stored addresses appears on the right side of the Control Display.

To select an address as destination:

1. Select address and confirm
2. Select "ROUTE GUID." and confirm.

1. ›Navigation‹
2. ›Destination input navigation‹
3. Select destination on the Control Display.

You can also edit existing entries in the address book; for conditions refer to "ABC...".

Home address

You can apply your home address into the destination entry.

Select  and confirm.

- ▷ "ROUTE GUID." applies the current home address as destination and destination guidance is started
- ▷ You can enter and edit the home address using the "ABC..." function
- ▷ "LOCATION" applies the current position as home address
- ▷ "AS ADDRESS" stores the entered address or current position as your home address.

Deleting addresses

Select  and confirm to delete all existing entries.

Voice command system address book

Storing addresses

The first destination in the destination list can be stored in this address book:

1. ›Navigation‹
2. ›Save destination‹
3. Enter a name to be assigned to the destination's map coordinates.

It is always the case that only the first entry in the destination list can be saved. To save other addresses, change the destination list accordingly, refer to page 136.

 The house number is not stored in the address book of the voice command system. ◀

Selecting an address

1. ›Navigation⟨
 2. ›Destination input with address⟨
 3. ›Select destination⟨
 4. Enter destination
- or
1. ›Navigation⟨
 2. ›Read out address book⟨
 - ▷ To scroll forward: ›Next⟨
 - ▷ To scroll back: ›Back⟨
 - ▷ To repeat: ›Repeat⟨
 - ▷ To import to destination list: ›Select⟨.

Home address

1. ›Navigation⟨
2. ›Route guidance to home⟨.

Deleting addresses

To delete individual entries:

1. ›Navigation⟨
2. ›Delete⟨
3. Select name.

To delete all current entries:

1. ›Navigation⟨
2. ›Delete address book⟨.

Current position

Display of current position

1. Select "Location" and confirm.



You can request the current position of your BMW or view a display showing your

map position. If the navigation system is unable to identify a town or city, your current map coordinates will appear.

If the navigation system recognizes the city, but not the street and intersection, you can enter these manually, refer to "ABC..." for instructions. The entry is applied as the current position with "ACCEPT".

"AS ADDRESS" can be used to import your current position into the address book; you can also enter a name as desired. Entry of a name is mandatory for locations identified only by their map coordinates.

"DELETE" deletes the entry from the address book.

Entering the current position

We recommend that you avoid entering subsequent corrections of your position unless absolutely necessary. After transport by truck or rail, etc., the GPS receiver may require several minutes to determine your current position. You can reduce the amount of time the system requires to determine your position by entering it manually.

To enter your current position:

1. Select "Location" and confirm
2. The procedure for entering your current position is the same as that used to enter your destination, refer to page 132.

▶ Once effective GPS reception has been established, it will no longer be possible to revise your position manually. ◀

What to do if ...

What to do if ...

- ▷ you request the current position of your vehicle, but do not receive a precise display?
The system is unable to receive enough GPS signals at your current position owing to obstructions, your position is not yet available on your navigation CD/DVD, or the system is in the process of calculating your position. Please wait and then try again later on
- ▷ the GPS logo disappears from the Control Display screen?
Reception is interrupted; a building or similar obstruction may be the cause
- ▷ the destination guidance refuses to import an address from the destination directory as its destination?
The address is not stored on the navigation CD/DVD currently in use. Choose an address as close as possible to the original one, using the destination entry map as required
- ▷ the destination guidance does not apply an address without the street?
No specified center is defined for the selected locality on your navigation CD/DVD. Enter any street, or a destination such as the railway station, etc., then start the destination guidance
- ▷ you want to enter an address for the destination guidance, but it is not possible to select the letters for your desired entry?
The address is not stored on the navigation CD/DVD currently in use. In this case, the system will not offer you any letters to choose from. Choose an address as close as possible to the original one, using the destination entry map as required
- ▷ the system stops furnishing directions on which way to turn as you approach intersections?
You are driving in an area that has not yet been completely recorded on the navigation CD/DVD. Instead of the turn-off arrow, an arrow appears that follows the course of the planned route, or
you have left the proposed route and the system requires a few seconds to calculate a new route proposal
- ▷ during destination guidance the destination route map is automatically displayed?
You are driving in an area that has not yet been recorded on the navigation CD/DVD. The destination guidance cannot operate under these conditions. However, you will see the current position of your BMW in the map display to help you orient yourself
- ▷ the battery has been disconnected?
It will take approx. 15 minutes for the system to resume operation.

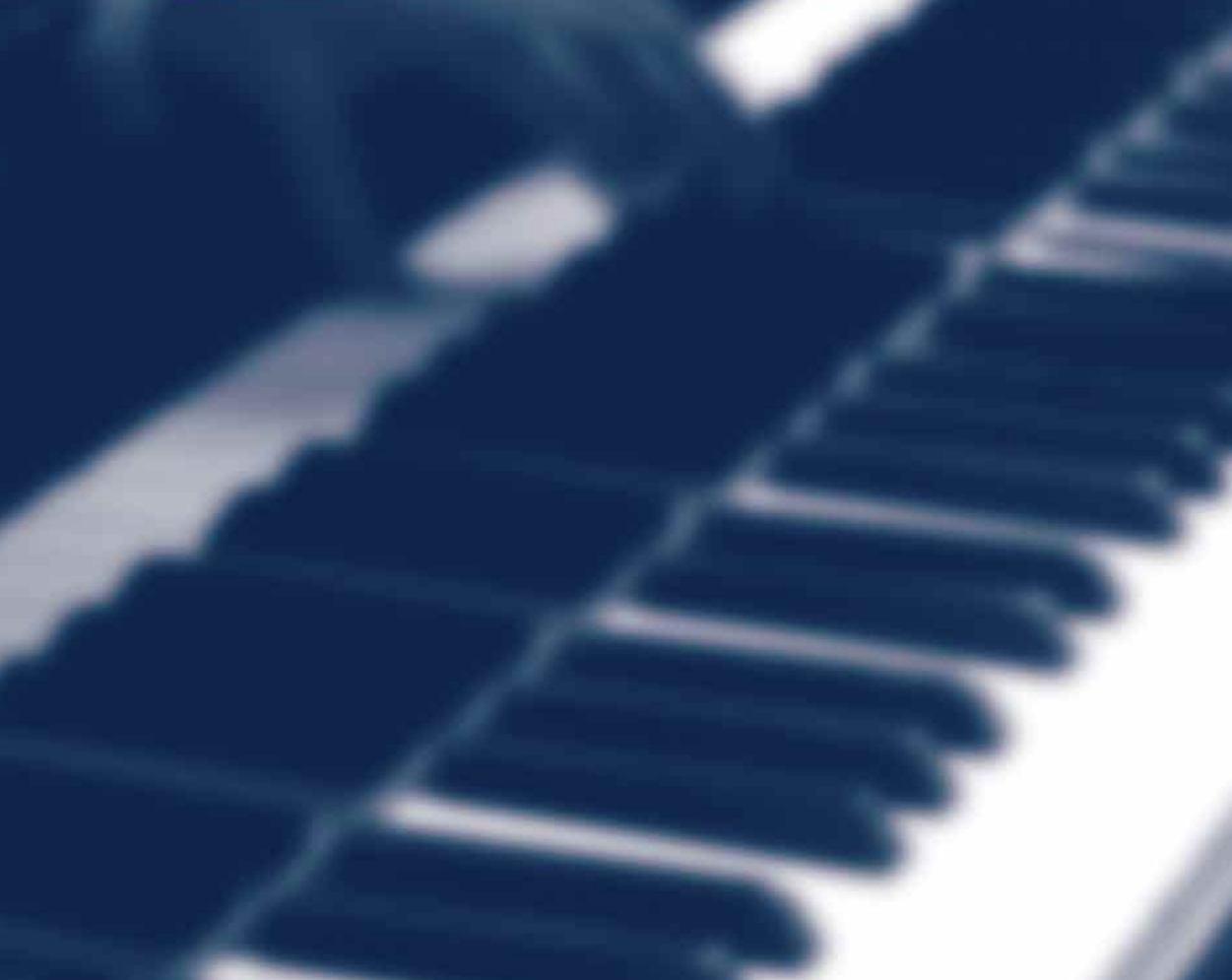



Entertainment

This chapter is intended to assist you in deriving maximum viewing and listening pleasure from radio and TV broadcasts, CDs or DVDs.

On/off, tone

Controls

Operation using buttons



The illustration shows a CD player as an example.

- 1 Operating audio and video sources
 - ▷ Press: switching on/off
 - ▷ Turn: adjusting volume
- 2 CD slot
- 3 Eject CD
- 4 Change station/track
 - ▷ Changing the station
 - ▷ Fast forward/reverse
 - ▷ Music track change for CD, change chapter for DVD changer
 - ▷ Change program for TV.

Operation using the Control Center

The following control options are available in the "Entertainment" menu.

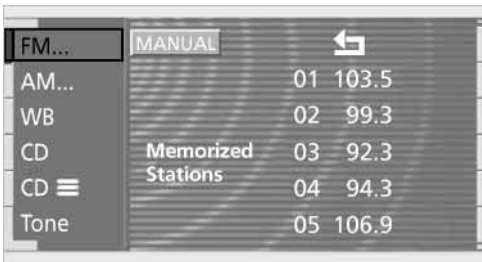

- ▷ "FM..." and "AM..."
Select waveband

- ▷ "WB"
Select Weather Band
If your vehicle is equipped with satellite radio, "SAT..." is located at this position, select satellite radio
- ▷ "CD" and **CD ≡**
Change audio source
- ▷ "Tone"
Set tone, e.g. treble, bass
- ▷ **TV** "Video" and **Audio**
Change to video or audio sources



- ▷ "TV" and "DVD"
Change video source
- ▷ "Picture"
Adjust picture
Select standard
Select picture format
- ▷ "Tone"
Set tone, e.g. treble, bass.

You can also control the radio, CD player, CD changer and the TV using the buttons on the steering wheel, refer to page 16, as well as via the voice command system, refer to page 25.

Operating temperatures

▶ The system is configured for operating temperatures of 5 °F / -15 °C to 140 °F / +60 °C. Outside this temperature range, malfunctions can occur. ◀

Care instructions

You can find everything you need to know on this topic by consulting the separate Caring for your vehicle brochure.

Switching on/off



Press the button.

The system returns to the most recently selected audio or video source, radio, CD, DVD or TV.

 'Radio' or 'Audio off'.

Using with ignition off

Switching the ignition off simultaneously deactivates the sound system.

To switch on again: press the button.

The audio and video functions remain available for use for a period of approx. 20 minutes after you switch off the ignition.

Volume adjustment

Adjusting the volume



Turn the button to the desired volume level.

 The sound system automatically reverts to its mute mode automatically whenever you use your telephone. ◀

 The system automatically selects your individual volume setting each time you unlock the vehicle using your personal remote control. ◀

Tone control

Playing audio recordings

You can choose from the following tone settings:

- ▶ Treble:
To amplify or reduce high frequencies
- ▶ Bass:
To amplify or reduce low frequencies
- ▶ Right/left volume balance, Balance:
Left or right, high/low volume
- ▶ Front-to-rear volume balance, Fader:
Front or rear, high/low volume
- ▶ Default settings, RESET:
Resets the tone settings to their standard default settings
- ▶ Speed-sensitive volume adjustment, Speed Volume
- ▶ Spatial sound effect Professional LOGIC7*
- ▶ Equalizer*.

 The speakers and headphones can be adjusted separately. The tone settings of the headphones are made in the rear screen with the headphones connected. Only treble, bass and balance can be adjusted. ◀

 The system automatically selects your individual tone setting each time you unlock the vehicle using your personal remote control. ◀

Tone adjustment

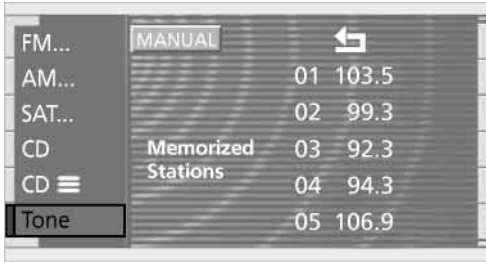

1. Select "Tone" and confirm

▶ For the sound settings of the TV or DVD, you can directly select "Tone" for the video sources and confirm. ◀

2. Select desired tone settings

▶ "Treble" and "Bass"



Select "Treble" or "Bass". Press and turn the controller to make the adjustment

▶ "Balance" and "Fader"

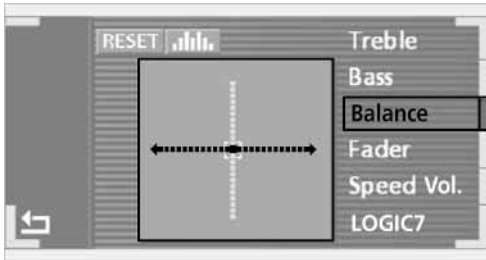

Select "Balance" or "Fader". Press and turn the controller to make the adjustment

▶ "Speed Vol."

Raises volume as vehicle speed increases. By pressing and turning the

controller, you can adjust the values between 1– 6

▶ "LOGIC7"*

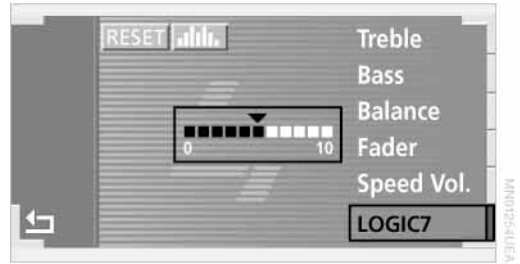

Select "LOGIC7". Press and turn the controller to make the adjustment.

You can set the spatial sound effect between the values 0 and 10. The best possible spatial sound lies at the values 5 and 6.

At 0, the spatial sound effect is switched off. This setting is suitable for radio plays, for example.

▶ LOGIC7 and the LOGIC7 logo are registered trade marks of Lexicon, Inc., a company of the Harman International Group. ◀

▶ Equalizer*

Select and confirm.

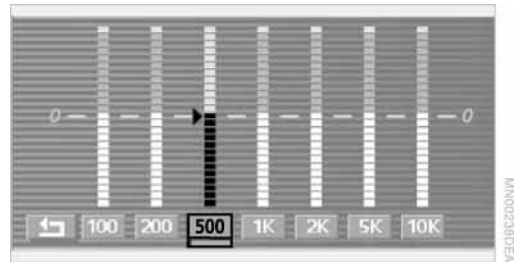

Turn the controller to select the desired frequency range. Repeated pressing and turning of the controller makes the adjustment.

Resetting the tone settings

You can reset all tone settings except "Speed Vol." to the standard default settings.

Select "RESET" and confirm.

Radio

Listening to the radio

1. Switch on audio or video sources, refer to page 149



If a video source is switched on, select "Audio" and confirm. ◀

2. If another audio source is switched on, select "FM..." or "AM..." and confirm.



◀Radio◀.

Volume adjustment, refer to page 149.

Tone control, refer to page 149.

Waveband selection

Your radio provides reception of the FM and AM wavebands.

To select waveband:

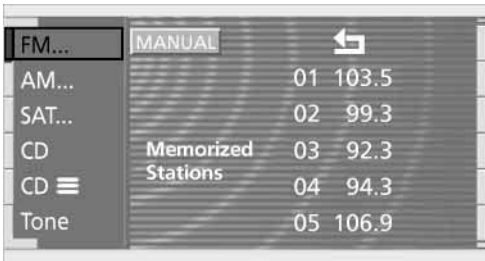

Select "FM..." or "AM..." and confirm.

Each time you confirm "AM..." the system alternately switches between the AM waveband and the "Autostore" mode.

Each time you confirm "FM...", the system alternately switches between "Memorized Stations" and the "Autostore" mode.



◀FM◀ or ▶AM◀.

Information display

The current waveband selection appears on the Control Display, for instance, in the FM waveband:

- ▷ Memorized Stations
FM Waveband

- ▷ 03

Number of memory location along with broadcast frequency.

The frequency of the current station can be seen in the lower status line of the Control Display, refer to page 23.

Station selection

You can search for a particular station by selecting its frequency.



1. ▶Radio◀
2. ▶Frequency 88 ..106 (Point 1 ..9)◀.

Using the Control Center

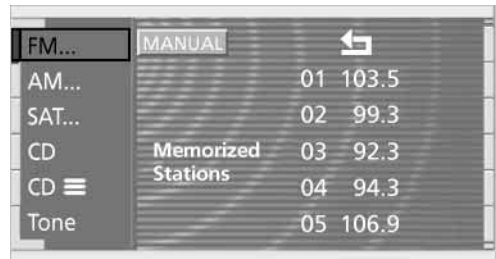

1. Select "FM..." or "AM..." and confirm.

Each time you confirm "AM..." the system alternately switches between the AM waveband and the "Autostore" mode.

Each time you confirm "FM...", the system alternately switches between "Memorized Stations" and the "Autostore" mode



◀FM◀ or ▶AM◀.

2. Select "MANUAL" and confirm.

Manual search



1. Select the frequency display and confirm
2. Turn the controller to set the frequency manually
3. Press the controller to confirm your entry.

Next station

◀▶ Select the desired direction and confirm.

The scan mode begins with the currently selected frequency.

The scan mode is stopped as soon as a station is found.

The frequency is shown on the Control Display.

The system switches to the next station.

1. ▶Radio◀
2. ▶Next station◀ or ▶Station back◀.

Sampling and selecting – scan

The automatic scan search feature automatically plays a brief sample from each station in the selected waveband.

1. Select "SCAN" and confirm.
Station search starts
2. Select a station
Confirm "SCAN" a second time.
This cancels the scan function, and the radio remains on the current station.

Buttons in the center console

Scanning



Extended pressure.

The scan mode begins with the currently selected frequency.

The scan mode is stopped as soon as a station is found.

The frequency of the station appears in the bottom status line, refer to page 23.

Next station



Press the desired direction.

The system switches to the next station.

1. ▶Radio◀
2. ▶Next station◀ or ▶Station back◀.

Storing and retrieving a station

Memory locations

Your radio can store 36 stations:

- ▶ You can store up to 18 stations in the FM waveband
- ▶ You can store up to 18 stations in the AM waveband.

▶ Each time you confirm "AM..." the system alternately switches between the AM waveband and the "Autostore" mode.

Each time you confirm "FM...", the system alternately switches between "Memorized Stations" and the "Autostore" mode. ◀

Storing a station

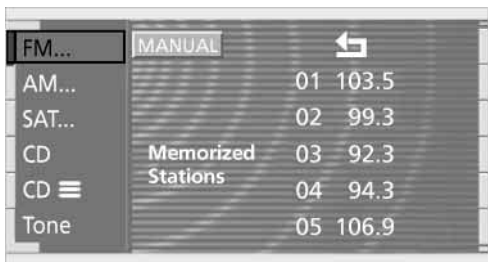

1. Select "FM..." or "AM..." and confirm.
Each time you confirm "AM..." the system alternately switches between the AM waveband and the "Autostore" mode.
Each time you confirm "FM...", the system alternately switches between "Memorized Stations" and the "Autostore" mode

›FM‹ or ›AM‹.

2. Select "MANUAL" and confirm
3. Select a station, refer to page 152.
The autostore utility's "AUTOSTORE" feature automatically selects and stores the stations providing the best reception in the AM and FM wavebands



4. Select "MEMORIZE" and confirm. For a manual search, refer to page 153, "MEMORIZE" is selected automatically

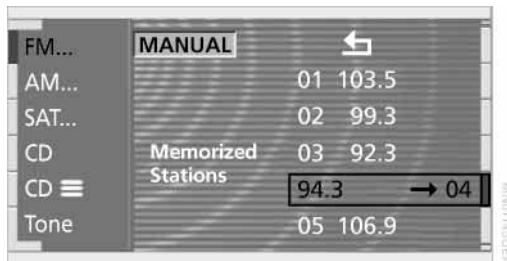

5. Turn the controller and select the memory location
6. Maintain pressure on the controller for several seconds.
The station is now stored.

Selecting a stored station

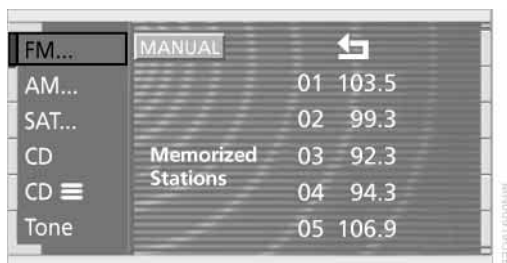

1. Select "FM..." or "AM..." and confirm.
Each time you confirm "AM..." the system alternately switches between the AM waveband and the "Autostore" mode.
Each time you confirm "FM...", the system alternately switches between "Memorized Stations" and the "Autostore" mode
2. Turn and press the controller to select a stored stations.

›FM‹ or ›AM‹.

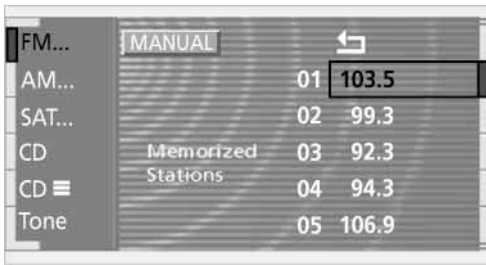

1. >Radio<
2. >Station 1 ..12<

Weather Band

Weather Radio is a service of the National Oceanic and Atmospheric Administration – NOAA – of the U.S. Department of Commerce. Weather messages are repeated every four to six minutes and are routinely revised every one to three hours, or more frequently if needed. Most of the stations operate 24 hours daily. During severe weather, National Weather Service forecasters can interrupt the routine weather broadcasts and substitute special warning messages. If you have a question concerning NOAA Weather Radio, please contact your nearest National Weather Service Office, or write to National Weather Service – Attn: W/OM11 –, National Oceanic and Atmospheric Administration, 1325 East-West Highway, Silver Spring, MD. 20910.

Selecting Weather Band

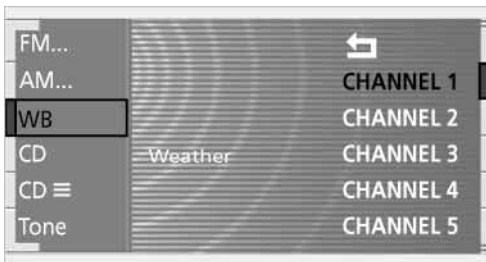

1. Select "WB" and confirm
2. Select channels and confirm.

With satellite radio:

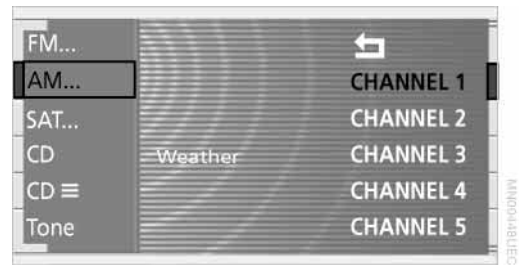

1. Select "AM..." and confirm
2. Each time you confirm "AM...", the system alternately switches between the "AM" and "Weather" mode
3. Select channels and confirm.

 In some regions, only one or two channels can be received or Weather Band stations are unavailable. ◀

Satellite radio*

You can receive approx. 100 different channels with high sound quality.

You can listen to one of these channels free of charge at any time to obtain a first impression. The channel is marked with ✓.

To listen to additional channels of your choice, you must have these channels enabled.

 You may experience signal drops and muting events related to this new technology. ◀

Enabling channels

1. Select "SAT..." and confirm.
The channels that can be received are shown in the list



2. Select a channel and confirm



3. Dial the displayed telephone number to have the system enabled.
During enabling, leave the ignition switched on.

Channel selection



1. Select "SAT..." and confirm.
Each time you confirm "SAT...", the system alternately changes between "Channels", "Category" and the "Presets".
The enabled channels are displayed with ✓
2. Select a channel and confirm

Additional information

3. Confirm channel once again.
The name of the artist, the title of the track and the name of the album are displayed.



Notes

As a rule, reception is guaranteed under a clear sky. If you are unable to receive any channel, the message "ACQUIRING..." appears in the status line. "DISPLAY ESN" shows the electronic serial number on the Control Display. The following also appear:

- ▷ "Call Sirius () to Subscribe", or
- ▷ "Call Sirius () to activate"

to subscribe or activate the selected channel.



When there is a signal blockage or the transmission is suspended momentarily for more than 4 seconds:

- ▷ Service may be interrupted or unavailable for specific reasons such as environmental or topographic conditions and other factors that Satellite Radio cannot directly control. The signal might not be available in tunnels, in parking garages, next to tall buildings, near trees with dense foliage, near mountains or other possible

strong sources of radio interference. Service should resume normally after the source of signal unavailability has been cleared. ◀

Selecting a category



1. Select "SAT..." and keep pressing until "Category" appears. The categories are shown in the category list
2. Select a category, e.g. "POP", and confirm. All the channels available in the category "POP" are displayed
3. Storing channels and selecting memory locations, refer to next section. Additional information, refer to page 156.

Storing a channel



1. Select "SAT..." and confirm
2. Select the desired channel
3. Select "STORE" and confirm. After confirming, you are in the preset list



4. Turn the controller and select a memory location where the channel is to be stored and press the controller for several seconds.

Selecting a stored channel

Turn the controller in the preset list to select and confirm stored channels. Up to twelve previously stored stations can be selected.

Next channel



Press to select the desired direction.

The next channel that appears on the Control Display is selected.

1. ›Radio‹
2. ›Station 1 ..12‹.

CD Compact Disc *

Listening to CDs

Insert the CD in the slot.

If a CD is already inserted in the CD player:

Start playback



Select "CD" and confirm.

1. \rightarrow CD \langle
2. \rightarrow CD on \langle .

Volume adjustment, refer to page 149.

Tone control, refer to page 149.

Selecting a track using the Control Center

Selecting music track

Select music track and confirm.



1. \rightarrow CD \langle
2. \rightarrow Track 1 ..30 \langle .

Listening to samples and selecting, Scan

The system plays a brief sample from each CD track.

1. Start sampling:
Select "SCAN" and confirm
2. Select a track:
Confirm "SCAN" a second time to cancel the scan function. Play resumes at the point on the CD at which sampling was interrupted.

Random play sequence

The music tracks on the CD are played in a random sequence.

To start random play:

Select "RND" and confirm.

To cancel random play:

Select any other function except track search.

 It is possible to hear the same song more than once. \blacktriangleleft

Selecting a track using buttons

Track search

Select the direction



Press repeatedly, continuing until you reach the desired track.

The CD will start play at the track selected.

1. \rightarrow CD \langle
2. \rightarrow Next \langle or \rightarrow Back \langle .

Fast forward/reverse

1. Select the direction



Press and hold the button. The tracks can be heard, but the sound is distorted

2. To interrupt the fast forward/reverse function, release the button. The CD will start play at the point selected.

Malfunctions

 The CD player is a Class 1 laser product. Never remove the cover from the housing. Do not operate the unit if the cover is damaged. Operation without the cover can lead to serious eye injury from invisible laser beams.

Always refer all repair and maintenance operations to qualified technicians.

With self-recorded CDs, labels applied later can become detached during playback due to the development of heat, causing irreparable damage to the device. ◀

 To prevent CDs from being copied illegally, they are often provided with copy protection by the manufacturer. Under certain circumstances this can prevent or restrict the playing of CDs on your CD player. In this case please contact the CD dealer or manufacturer. ◀

If you play self-recorded audio CDs, faults, e.g. drop-outs, can occur, or the CD is not played at all.

 High levels of humidity inside the player can condense on the laser's scan lens and prevent it from reading the CD. ◀

CD changer*

Location

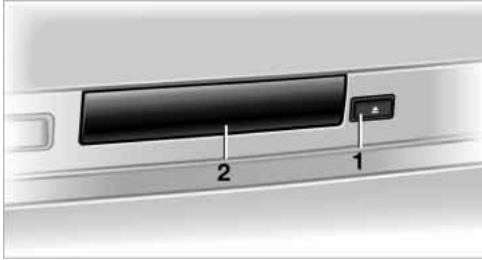

The BMW CD changer with a storage capacity of 6 CDs is installed above the glove compartment.

Removing the CD magazine

To insert or remove CDs from the CD magazine you must first remove it from the CD changer:

1. Press button 1; the lid 2 opens
2. The CD magazine is ejected and can be removed.

Inserting/removing CDs from the CD magazine



When inserting or removing CDs always remember to grasp them on the edge, taking care to avoid touching the data side with its mirror finish.

- ▷ To insert:
Insert the CD in its slot with the label side on top
- ▷ To remove:
Pull out the desired drawer and remove

the corresponding CD, as shown in the illustration.

Inserting the CD magazine

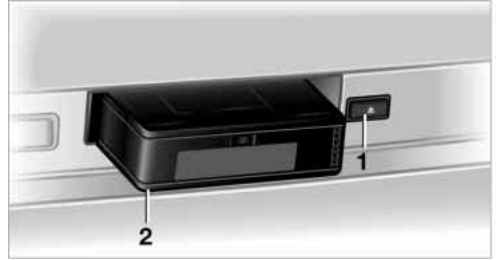

1. Press button 1; the lid opens
2. Ensure that the arrow symbol is pointing toward the CD player and slide the magazine 2 all the way in. The lid closes automatically.

 The CD changer automatically reads in the loaded CDs and is then ready for operation. ◀

Listening to CDs

1. Insert the CD magazine

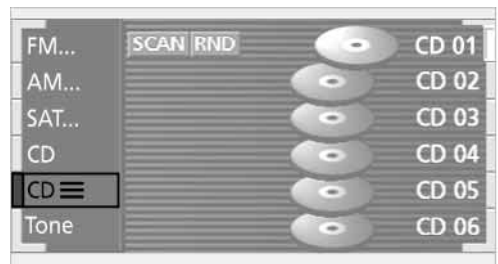

2. Select **CD ≡** and confirm.

After a few seconds, play will resume at the point where the CD stopped earlier.

If the CD magazine has been newly filled, playback begins with the lowest CD, e.g. CD 1, track 1.

1. **▶**CD changer[◀]
2. **▶**CD on[◀].

Volume adjustment, refer to page 149.

Tone control, refer to page 149.

 If you play self-recorded audio CDs, faults, e.g. drop-outs, can occur, or the CD is not played at all. ◀

Status displays

The CD magazine's load status is indicated on the Control Display.

 If the display fails to detect a CD that you have loaded in the magazine, check to ensure that the CD has been inserted correctly and inspect it for signs of defects. ◀

Selecting a track using the Control Center

Selecting a CD

Select CD and confirm.

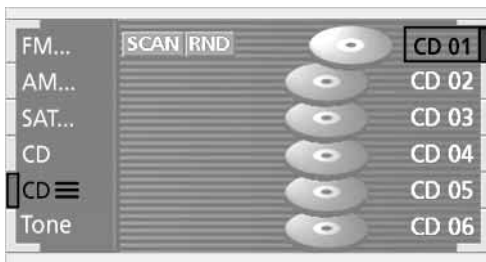

Playback starts on the first track. At the end of the last track, the next CD will be selected.

 **▶**CD 1 ..6[◀].

Sampling and selecting – scan

The system automatically plays a brief sample from each of the tracks on the current CD.

1. Start sampling:
Select "SCAN" and confirm.
The scan function starts with the next track. Once all tracks have been played once, the next track is played
2. Select a track:
Confirm "SCAN" a second time to cancel the scan function. Play resumes at the point on the CD at which sampling was interrupted.

Random play sequence

In this mode the music tracks on the current CD are played in a random sequence.

To start random play:

Select "RND" and confirm.

To cancel random play:

Select any other function except track search.

Selecting a track using buttons

Track search

Select the direction



Press repeatedly, continuing until you reach the desired track on the current CD. The CD will start play at the track selected.

1. **▶**CD changer[◀]
2. **▶**Next[◀] or **▶**Back[◀].

Fast forward/reverse

1. Select the direction



Press and hold the button. The tracks can be heard, but the sound is distorted

2. To interrupt the fast forward/reverse function, release the button. The system will continue play at the

point on the CD at which the button was released.

Selecting music track

1. >CD changer<
2. >Track 1 ..30<.

Malfunctions



The BMW CD changer is a Class 1 laser product. Never remove the cover from the housing. Do not operate the unit if the cover is damaged. Operation without the cover can lead to serious eye injury from invisible laser beams. Always refer all repair and maintenance operations to qualified technicians. With self-recorded CDs, labels applied later can become detached during playback due to the development of heat, causing irreparable damage to the device. ◀



To prevent CDs from being copied illegally, they are often provided with copy protection by the manufacturer. Under certain circumstances, this can prevent or restrict the playing of CDs on your CD changer. In this case please contact the CD dealer or manufacturer. ◀

If you play self-recorded audio CDs, faults, e.g. drop-outs, can occur, or the CD is not played at all.





High levels of humidity inside the player can condense on the laser's scan lens and temporarily prevent it from reading the CD. ◀

For your own safety, the TV picture is only shown on the rear screen.

 The system is designed for reception of analog television. Due to the quality of mobile reception, reduced picture quality can result depending on the position and network coverage in spite of the highly advanced reception technology used. A change in vehicle positions can result in improved reception quality in many cases. ◀

Television

1. Switch on audio or video sources, refer to page 149

 If an audio source is switched on, select  "Video" and confirm. ◀



2. Select "TV" and confirm.

The device selects the last program set.

 ›TV on◁.

Volume adjustment, refer to page 149.

Tone control, refer to page 149.

 All menu items will disappear from the screen after a brief pause if you do not make any additional entries. ◀

Storing programs

The programs with the strongest reception are automatically stored and continuously adjusted to the respective reception situation.

Selecting programs

Using the Control Center

1. Press controller to view the programs
2. Select program and confirm

Button in the rear



Press the button in the desired direction the number of times required to reach program you want.

1. ›TV◁
2. ›Next◁ or ›Back◁.

Adjusting the picture*

 During reception, the menu items are displayed by pressing the controller. ◀

1. Select "TV" and confirm
2. Select "Picture" and confirm.



Additional menu items are displayed on the right side.

Selecting brightness, color, contrast and tint

Select "Brightness", "Color", "Contrast" or "Tint". Press and turn the controller to make the adjustment.

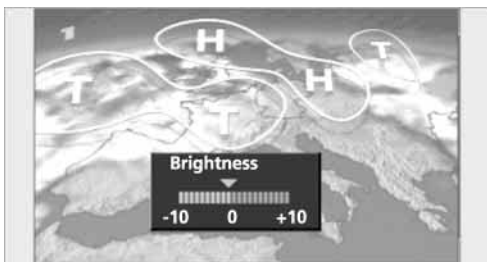

Selecting standard

Television programs can be received worldwide with the multi-standard receiver for PAL, SECAM, NTSC.

The TV standard used is not the same in all countries. However, you can change over your TV receiver to all common TV standards.

 During reception, the menu items are displayed by pressing the controller. ◀

1. Select "TV" and confirm
2. Select "Picture" and confirm
3. Select "TV format" and confirm
4. Select the country you are currently in from the list displayed and confirm.

DVD changer *

Location

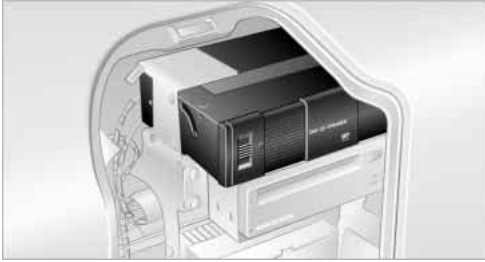

The BMW DVD changer for 6 DVDs or audio CDs is mounted behind the left side trim panel in the luggage compartment.

Removing the DVD magazine

To insert or remove DVDs or CDs from the magazine, you must first remove it from the DVD changer:



1. Push the door to the right, refer to arrow 1
 2. Press the button, refer to arrow 2.
- The magazine is ejected and can be removed.

Inserting/removing DVDs or CDs from the DVD magazine



When inserting or removing DVDs or CDs, always remember to grasp them on the edge, taking care to avoid touching the data side with its mirror finish.

- ▶ To insert:
Insert the DVD or CD in its slot with the label side on top
 - ▶ To remove:
Pull out the desired drawer and remove the corresponding DVD or CD, as shown in the illustration.
-  Dual-sided DVDs available from retail suppliers are coated on both sides and bear no markings. This means both sides are information carriers. To playback the information on the other side, remove the magazine and turn over the DVD. If you play self-recorded audio CD-Rs, faults, e.g. drop-outs, can occur. ◀

Inserting the DVD magazine



1. Push the door to the right
2. Ensure that the arrow symbol is pointing toward the DVD changer and slide the magazine all the way in
3. Close the door again.

 The DVD changer checks the magazine for inserted DVDs or CDs and is then ready for operation. ◀

DVD country codes

Your DVD changer only plays DVDs with the coding 0 or 1. This coding cannot be changed.

Playing DVDs

 Make all entries with the vehicle stationary. If you do not observe this precaution, you may endanger vehicle occupants and other road users. ◀

1. Insert the DVD magazine



2. Select "DVD" and confirm.

After a few seconds, play will resume at the point where the CD stopped earlier.

 If the DVD magazine has been newly filled or an audio CD played from the DVD magazine, playback begins with the lowest DVD in the DVD magazine. ◀

 'DVD on'.

Volume adjustment, refer to page 149.

Tone control, refer to page 149.

Status displays

The DVD magazine's load status is indicated on the Control Display.

 If the display fails to detect a DVD that you have loaded in the magazine, check to ensure that the DVD has been inserted correctly and inspect it for signs of defects.

If there are audio CDs in the DVD magazine, these will not be displayed in the DVD menu, but instead in the CD changer menu. If your vehicle is equipped with an additional CD changer, they will be displayed with the numbers 7 to 12. ◀

DVD control

With the DVD control you can select the track and chapter, display the DVD-specific menu and operate functions such as Language, Fast forward and Reverse or Freezing frame.

A DVD can briefly deactivate functions of the DVD control, under certain circumstances while the entire DVD is being played. You are then unable to operate the DVD control. In this case, attempt to make the selection using the DVD-specific menu.

Display DVD control:

1. Select "DVD" and confirm
2. Wait briefly until all menu items have disappeared, then press controller.



MAN00900000

2. Display DVD control, refer to page 166



MAN00900000

The DVD control disappears again after a short time if you have not selected a function.



During playback the DVD control is displayed by pressing the controller. ◀

Softkey	Function
▶	Start playback
■	Stop playback
⏪	Close DVD controller
⏸	Activate and deactivate freezing frame
⏮ ⏭	Searching for chapter
⏮ ⏭	Fast forward/reverse
⬆ ⬇ ⬆ ⬅	DVD-specific menu: Select functions
⏪	DVD-specific menu: Return to previous menu

Selecting a track

Several tracks can be stored on a DVD.



MAN00900000

1. Select DVD and confirm.
Playback begins after a few seconds

3. Select "FULL MENU" and confirm
4. Select "TITLE" and confirm
5. Turn and press the controller to select the desired track.
Playback begins at the track selected.

Fast forward/reverse

1. Display DVD control, refer to page 166
2. Select the direction
⏮ ⏭
and confirm
3. To increase the fast forward/reverse speed, press the controller several times.
The DVD playback will be distorted
4. End fast forward/reverse:
Select ▶ and confirm.
The DVD will start play at the point selected.



When the DVD is playing, fast forward/reverse is started by turning the controller. The speed can be increased by turning the controller further. To interrupt the fast forward/reverse function, release the controller. The system will continue play at the point on the DVD at which the controller was released. ◀

Searching for chapter



You can change to the next or previous chapter during playback. ◀

1. Display DVD control, refer to page 166
2. Select the direction



and confirm repeatedly, continuing until you reach the desired chapter

or with buttons

Select the direction



Press repeatedly, continuing until you reach the desired chapter on the current DVD.

Playback begins at the chapter selected.

Adjusting the picture

1. During playback, press controller
2. Select and confirm
3. Adjust the picture, refer to page 164.

Freezing frame

1. Display DVD control, refer to page 166
2. At the desired position, select and confirm.
The film is stopped
3. To restart the DVD:
Select or and confirm.
DVD playback is continued at the point at which it was interrupted.

Selecting picture format

You can adjust the DVD format to your screen.

The picture format is a DVD-specific function and is not offered by all DVDs.

1. Display DVD control, refer to page 166
2. Select and confirm
3. Select and confirm
4. Select "Picture" and confirm



5. Select "Pict. format" and confirm
6. Select the desired picture format and confirm.

Selecting language, subtitles and viewing angle

Many DVDs offer dialogs and subtitles in various languages or scene descriptions for the hearing impaired. In addition, with some DVDs the film can be viewed from different camera angles. These functions are stored on the DVD.

To select functions:

1. Display DVD control, refer to page 166
2. Select "FULL MENU" and confirm.



- ▶ Select "AUDIO" and confirm.

You can select from the various languages by turning and pressing the controller

- ▶ Select "SUBTITLE" and confirm.

You can display the subtitles in the language of your choice by turning and pressing the controller

- ▶ Select "ANGLE" and confirm.

You can change the camera angle by turning and pressing the controller. Notes or symbols that appear during the playback of a film generally point out different camera angles. These are usually only briefly available.

 With some DVDs the language, subtitles or camera angle is only possible with the DVD-specific menu. Refer to the information on your DVD for possible selections. ◀





Opening DVD-specific menu

Additional functions may be available on DVDs. For example, the viewer can select from several possible plots or display information on the film.

1. Display DVD control, refer to page 166
2. Select "MENU" or "TOP" and confirm.

 With "MENU" you can generally open the DVD-specific main menu. On some DVDs you will find an additional menu called "TOP" in which, for example, you can select music scenes. ◀

To make a selection:

1. Use     to select a function
2. Confirm selection with "OK".

To return to a previous menu:

Select  or  and confirm.

 Language, subtitle or angle can also be selected in the DVD-specific menu.

Refer to the information on your DVD for possible selections. ◀

Malfunctions/notes

 The BMW DVD changer is a Class 1 laser product. Never remove the cover from the housing. Do not operate the unit if the cover is damaged. Operation without the cover can lead to serious eye injury from invisible laser beams.

Always refer all repair and maintenance operations to qualified technicians. With self-recorded CDs or DVDs, labels applied later can become detached during playback due to the development of heat, causing irreparable damage to the device. ◀

 Macrovision copy protection: This product incorporates copyright protection technology that is protected by method claims of certain U.S. patents and other intellectual property rights owned by Macrovision Corporation and other rights owners. Use of this copyright protection technology must be authorized by Macrovision Corporation, and is intended for home and other limited viewing uses only unless otherwise authorized by Macrovision Corporation. Reverse engineering or disassembly is prohibited. ◀

 To prevent CDs from being copied illegally, they are often provided with copy protection by the manufacturer. Under certain circumstances this can prevent or restrict the playing of CDs on the DVD changer. In this case please contact the CD dealer or manufacturer. ◀

If you play self-recorded audio CDs, faults, e.g. drop-outs, can occur, or the CD is not played at all.

The DVD changer can play the following formats:

- ▷ Video DVD
- ▷ CD-DA, Audio CD
- ▷ CD-R.



The DVD Audio format is not supported by the DVD changer. However, many audio DVDs available in stores also contain a video track in the DVD Video format in addition to the audio track. These DVDs can be played back by the DVD changer. Please refer to the information on your DVD to determine whether your audio DVD contains an additional video track. DVDs are usually divided into tracks and chapters and can contain different subtitles, camera angles or sound tracks, languages and sound formats. Depending on the version of the DVD, these functions can be selected either directly with the DVD control system or only via the DVD-specific menu. Refer to the information on your DVD for possible selections.

High levels of humidity inside the player can condense on the laser's scan lens and prevent it from reading the DVD. ◀



Communications

This chapter describes the extensive array of options available for mobile communications with family, friends, business associates and service providers.

Using the phone in your vehicle

Safety notes

A car phone can provide many services, in an emergency even initiating a lifesaving rescue. However, bear the following in mind:

Adjustments

 To avoid posing an unnecessary hazard due to inattention, both to your own vehicle's occupants and to other road users: never attempt to use the controls or make entries unless traffic and road conditions allow. ◀

Using the phone in your vehicle

 Using a portable phone to make and receive calls while driving is now illegal in virtually every country in the world. Always use your hands-free system, or stop your vehicle in an area where you will not pose a safety hazard to other road users and switch the engine off. ◀

Antenna

 When using the phone, ensure that all persons in the area are at least 20 in/50 cm from the antenna. Never use your BMW portable phone if the antenna is damaged. Contact between your skin and a damaged antenna can result in minor burns.

If the antenna is damaged, have it replaced immediately. ◀

Special environmental conditions

 Do not use your phone from within a garage, or near an open hood. The air in these areas could contain fuel vapors, and the phone might generate sparks that could result in burns.

This same precaution applies to opening luggage compartment lids on vehicles equipped for operation using natural gas or hydrogen, and to all vehicles with luggage compartment-mounted batteries.

Always switch off your BMW portable phone in areas where blasting work is being conducted with explosives. The phone signals could potentially act as a high-frequency transmitter and set off explosions.

Always switch off your BMW portable phone in areas where an increased explosion danger is present. This category includes filling stations along with fuel and chemical storage depots, etc., and all areas in which the air can contain fuel, chemicals or metal particles. Under these conditions, your BMW portable phone could conceivably generate sparks that could lead to a fire or explosion. Always observe all legal regulations governing the use of portable phones in the vicinity of filling stations, chemical factories and other areas where an explosion potential exists. Never use the BMW portable phone in hospitals, care centers or at other locations where medical equipment may be in operation, such as accident sites, etc. Your service provider can furnish you with more detailed information on legal regulations governing the use of your phone. ◀

Medical equipment

 Portable phones can generate interference capable of preventing hearing aids and cardiac pacemakers from operating correctly. If you or any occupant of the vehicle will be using such equipment, consult a physician or the manufacturer of the equipment to determine whether it is adequately shielded against high-frequency energy.

Persons with cardiac pacemakers should bear the following in mind:

Always hold the switched-on BMW portable phone more than 15 cm away from the cardiac pacemaker.

Do not carry the BMW portable phone in your breast pocket.

Use the ear on the opposite side of the cardiac pacemaker to reduce the likelihood of

influencing the cardiac pacemaker. With the slightest sign of a cardiac pacemaker malfunction, switch the BMW portable phone off immediately. ◀

Batteries

 To avoid possible short circuits, after removing a battery you should never allow it to come into contact with metallic surfaces of any kind. This is why you should handle charged batteries with care, in particular if you place batteries, e.g. in jacket or shirt pockets that contain metal objects. If you are in an environment where there is a risk of explosion, do not remove the battery from the device, as otherwise sparks from your battery could cause explosions or fire. ◀

Disposing of used batteries

 Return used batteries to a recycling collection point or to your BMW center. ◀

Care instructions

You can find useful information on caring for your portable phone in the separate Caring for your vehicle brochure and in the separate portable phone Owner's Manual.

Controls

You have the option of making phone calls with the car phone* or the BMW portable phone.

If there is no BMW portable phone in the cradle, the Personal Calling connection is set up with the car phone.

 The car phone must be enabled prior to initial use. In this connection, please consult your BMW center. ◀

The telephone used to set up a connection appears in the upper status line.

 For information on operating your portable phone, please consult the separate Owner's Manual. ◀

The phone can be operated by means of:

- ▷ The steering wheel, refer to page 16
- ▷ The Control Center
- ▷ The folding telephone keypad
- ▷ The voice command system – not for incoming calls.

Control Center

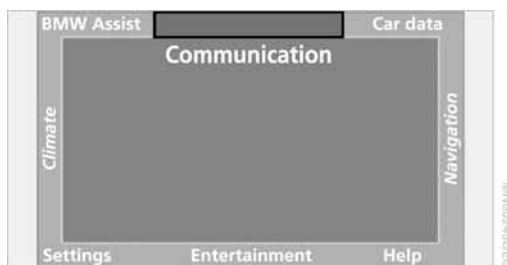

You can use the following functions in the Control Center:



- ▷ The phone book, only with BMW portable phone
- ▷ The Top 8 list, only with BMW portable phone
- ▷ The redial list.

After selecting the desired entry, a connection can be set up via:

- ▷ The button on the steering wheel
- ▷ The folding telephone keypad
- ▷ The Control Center.

Here, the dialed number appears in the upper status line, refer to page 23.

Missed calls are also shown in a list if this service is supported by your network provider.

You can use  and  to change between the two pages of the "Communication" menu.

Telephone keypad, folding

The telephone keypad allows you to use all of the basic telephone functions without ever picking up the receiver. Calls are automatically routed through the hands-free system.

 The telephone keypad is available for operation at the radio mode in the ignition lock, refer to page 60. ◀

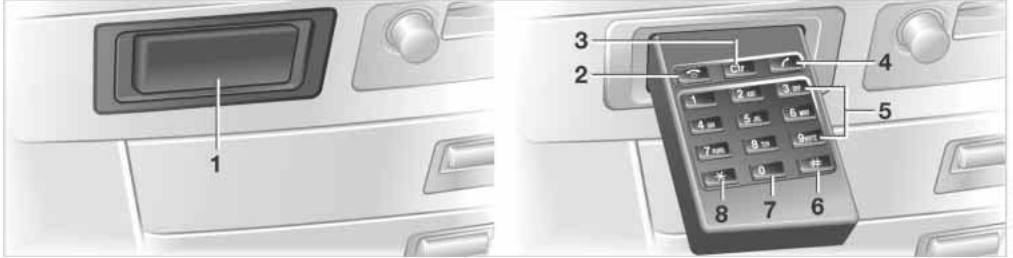



- 1 Briefly press the telephone keypad, it will extend automatically.

When you are done using the telephone keypad, press it back in, continuing until the detent engages



It is not possible to remove the telephone keypad. ◀

- 2  Press briefly: terminate call
Press longer: switches BMW portable phone on and off
- 3  Press briefly: delete the last character entered
Press longer: delete the entire number

- 4  Press briefly: dial or accept call

- 5  Enter digits 1 - 9



- 6  Special character entry

- 7  Enter the digit 0

- 8  Press briefly: enters the special character
Press longer: pause for dialing in the touch tone mode

Hands-free system

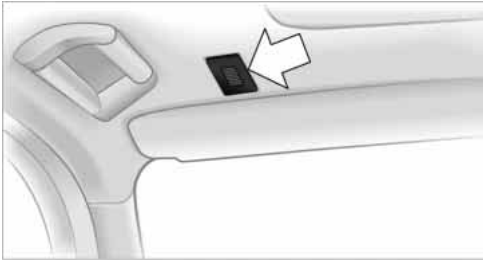

The hands-free microphone is located on the front headliner.

The hands-free system is activated whenever you establish or receive a call using the following:

- ▷ Control Center, page 175
- ▷ Voice command system, page 25, not for incoming calls
- ▷ Buttons on the steering wheel, page 16
- ▷ Telephone keypad, folding, page 176.

Volume adjustment

You can adjust the volume for the hands-free unit:



Turn the button during a call to select the desired volume.

The hands-free unit will remain at this volume level, even if the other audio sources are set to minimum volume.

 The system automatically selects your individual volume setting each time you unlock the vehicle using your personal remote control. ◀

Starting an emergency call

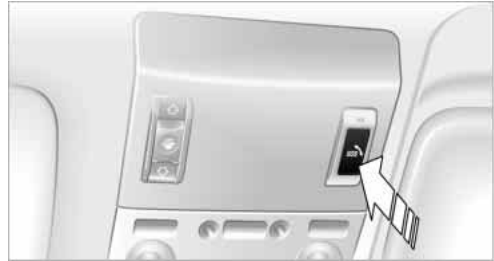

1. Open the protective cover: Briefly press the protective cover
2. Press the emergency call button for at least 2 seconds.

Conditions for an emergency call:

- ▷ The wireless communications network is available
- ▷ The emergency call system is operable.

Once the button is pressed, the indicator LED on the switch will flash for the duration of the call.

If the vehicle is equipped with a navigation system and BMW Assist, the phone system will automatically establish contact with the BMW Assist emergency call center. The system also transmits the vehicle's current position to the center at the same time.

 If the navigation system fails, the current position of the vehicle is not transmitted. ◀

Following transmission of the data a confirmation report will appear on the Control Display. The emergency call center can initiate immediate action for emergency assistance.

If it is repeatedly not possible to set up a connection to the BMW Assist emergency call center, a connection to the general emergency call number 911 is set up.

 If conditions allow, remain in the vehicle until the connection has been established. You will then be able to provide a detailed description of the situation. Misuse of the emergency call system is forbidden under penalty of law. ◀

Under certain conditions, an emergency call is started automatically immediately after a severe accident. The automatic emergency call is not affected by the emergency call button being pressed.

Telephoning with the car phone*

Currently not available

If the BMW portable phone is not in the cradle, you can telephone using the car phone via the hands-free unit.

The telephone that can be used to set up a connection is shown in the upper status line on the Control Display.

 The car phone must be enabled prior to initial use. In this case, please consult your BMW center. ◀

Calls can be set up or accepted using the following equipment:

- ▷ Control Center, page 175
- ▷ Voice command system, page 25, not for incoming calls
- ▷ Buttons on the steering wheel, page 16
- ▷ Telephone keypad, folding, page 176.

Commissioning the BMW portable phone

Precondition for portable phones with SIM card:

- ▷ You might have to enter a Personal Identification Number, PIN
- ▷ Release all keypad guards, refer to separate Owner's Manual.

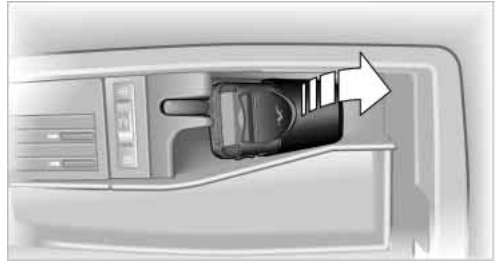

BMW/SCS/CHINA

1. Fold back the cradle slightly
2. Insert the portable phone.

 Before starting off place the BMW portable phone in the cradle. You can then operate the portable phone using the button on the steering wheel, the Control Center, the telephone keypad or the voice command system, but not if you are in the middle of a call using the car phone. If you are in the middle of a call using the BMW portable phone, the connection will be cut off as soon as you take it from the cradle. ◀

Switching your BMW portable phone on and off

 You can switch your BMW portable phone on and off by maintaining extended pressure on the telephone keypad.

For portable phones with a SIM card, you might have to enter the PIN after switching on.

 Telephone on ◀

Entering lock code

If, after switching on the BMW portable phone, you are requested by a message from the Control Display to enter the lock code:

1. Enter the lock code, e.g. 1234
2. Press the button



Getting started

Making a call

1. Enter the desired phone number
2. Press the button



The phone number appears in the Control Display's status line.

1. ›Dial number‹
2. Enter the phone number
 - ▷ Listen to the entered numerical sequence:
 - ›Read out‹
 - ▷ Delete the entire number:
 - ›Delete‹
3. ›Dial‹.

Always remember to enter the complete telephone number, including the area code, even if you are currently in the same area as the number that you wish to contact. ◀

Ending a call

Press the button



Phone book

You must enter your portable phone's phone book in the voice command system before it will be available for access using voice commands. This creates a special voice command phone book. If changes are then made to the phone book using the voice command system, these modifications will apply exclusively to the voice command phone book, and not to the phone book in the portable phone.

Creating and updating voice command phone book*

1. ›Telephone‹
2. ›Update telephone book‹.

The entries in the portable phone's phone book appear sequentially in the Info Display.

You must assign a specific name to each number that you wish to transfer to the voice command phone book. These numbers will no longer be requested during updates.

Making a new entry in the voice command phone book

1. ›Save name‹
2. Enter name and repeat entry upon request
3. Enter phone numbers
4. ›Save‹.

Dialing from the phone book

1. Select "Communication"



- ▷ Select "A-Z" and confirm.

A listing of all the entries in the phone book appears on the right side of the Control Display

- ▷ Select "1,2,3" and confirm.

An alphabetical listing of all the entries in the phone book appears on the right side of the Control Display

2. Establishing a connection after selecting and confirming the desired entry. Here, the dialed number appears in the upper status line, refer to page 23.

The system dials the number.

 The connection can also be set up using the button on the steering wheel or the telephone keypad. ◀

-  1. ›Select name◁
2. Enter name.

 Ends a call

Viewing entries

-  ›Read out◁
 - ▷ To scroll forward: ›Next◁
 - ▷ To scroll back: ›Previous◁
 - ▷ To repeat entry: ›Repeat◁
 - ▷ To call: ›Dial◁.

Deleting individual entries

-  1. ›Telephone◁
2. ›Delete entry◁
3. Enter name.

Deleting the entire phone book

-  1. ›Telephone◁
2. ›Delete telephone book◁.

Selecting a number from the Top 8 list

The eight numbers that you call most frequently on the BMW portable phone are automatically stored in the Top 8 list. The number called most often appears at the top of the list.

1. In the "Communication" menu, select "TOP 8" and confirm
2. Select an entry from the list that now appears in the display and confirm
3.  Establishing a connection. Here, the dialed number appears in the upper status line, refer to page 23.

 The connection can also be set up using the button on the steering wheel or the telephone keypad. ◀

 Ends a call.

Redialing

Both numbers that you reached on your earlier attempt and numbers that were unavailable are automatically stored in your redialing list. The last number dialed is at the top of the list.

1. Select "Communication"



2. Select "Last" and confirm
3. Select an entry from the list that now appears in the display, and confirm
4.  Establishing a connection. Here, the dialed number appears in the upper status line, refer to page 23.

 The connection can also be established using the button on the steering wheel or the telephone keypad. ◀

You can use the voice command system to redial the last number called:

-  ›Redial◁.

 Ends a call.

Missed calls

If the phone number of the caller was transferred, you can have a list of all missed calls displayed if this service is supported by your network provider.

1. Select "Communication"



2. Select "Missed" and confirm
3. Select an entry from the list that now appears in the display, and confirm
4.  Establishing a connection. Here, the dialed number appears in the upper status line, refer to page 23.

 The connection can also be established using the button on the steering wheel or the telephone keypad. ◀

 Ends a call.

BMW Assist*

 To avoid posing an unnecessary hazard, both to your own vehicle's occupants and to other road users, only make entries with the vehicle stationary. ◀

Requirements

If the following requirements are met, you can call up BMW Assist:

- ▷ Telephone is connected and switched on
- ▷ The lock code has been entered
- ▷ The mobile communications network is available
- ▷ GPS reception for transmission of the data is ensured.

 The position of the vehicle can influence the mobile communications/GPS reception. As a rule, mobile communications/GPS reception is only possible under a clear sky.

When vehicle data is exchanged with the BMW center, a corresponding message appears on the Control Display. ◀

Roadside Assistance of the BMW Group

Here, you automatically dial the number of the Roadside Assistance of the BMW Group, your BMW center or BMW Customer Relations.

To contact Roadside Assistance, for example in the event of a breakdown:

1. Select "BMW Assist" and confirm your selection
2. Select "BMW Services" and confirm your selection

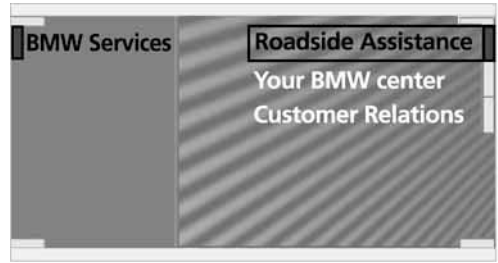

3. Select "Roadside Assistance" and confirm your selection.
The current vehicle position is displayed

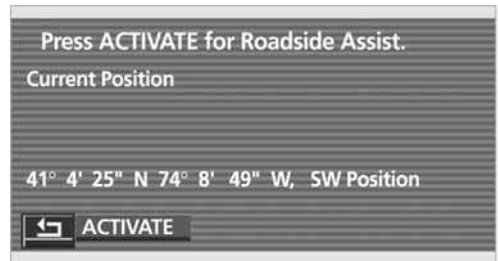

4. Select "ACTIVATE" and confirm your selection.
The data of your vehicle is transmitted to BMW center.

The BMW center forwards the current vehicle position and the customer profile, the vehicle data, to the relevant Roadside Assistance service. Voice communication to the Roadside Assistance service is set up.





Mobility

This section helps you maintain your mobility by supplying important information on vital topics including fuels and lubricants, wheels and tires, service, maintenance and how to deal with any problems that may occur.

Refueling

Fuel filler door



⚠ Always switch off the engine before refueling. If you do not, fuel cannot be filled into the tank and a message will appear in the Check Control. ◀

To open and close: briefly press the rear edge of the fuel filler door.

Manual release

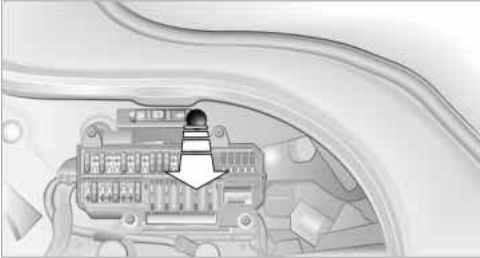

In the event of an electrical defect in the system, you can release the fuel filler door manually:

1. Lift the handle to remove the cover panel on the right side of the luggage compartment
2. Take the button with the fuel pump symbol from the bracket and pull it to unlock the fuel filler door.

⚠ Always observe all applicable precautions and regulations when handling fuels. Never carry spare fuel containers in your vehicle. Whether empty or full, these containers can leak, cause an explosion, and lead to fire in the event of a collision. ◀

Simple and environmentally friendly

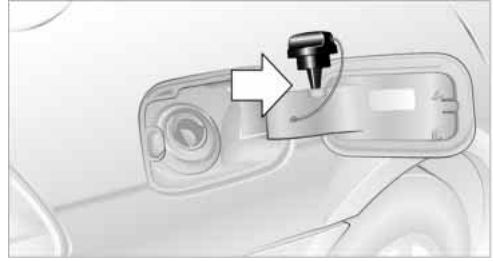

⚠ When handling fuels always observe any safety guidelines posted at the filling station. ◀

Put the filler cap in the bracket attached to the fuel filler door.

When refueling, insert the filler nozzle completely into the filler pipe. Lifting the filler nozzle during refueling

- ▷ results in premature pump shutoff
- ▷ can lead to reduced efficiency in the fuel-vapor recovery system.

The fuel tank is full when the filler nozzle clicks off the first time.

⚠ Close the filler cap carefully after refueling, continuing until you hear the detent engage. While closing, be sure not to squeeze the strap which is fastened to the cap. A loose or missing cap will activate a message in the Check Control. ◀

Fuel tank capacity: approx. 23.2 gallons/ 88 liters, including the reserve capacity of approx. 2.6 gallons/10 liters.

⚠ Never attempt to continue driving until the tank is completely empty, as engine functions could be affected, and the vehicle could sustain damage as a result. ◀

Fuel specifications

The engine uses lead-free gasoline only.

Required fuel:

- ▷ Premium Unleaded Gasoline, min. 91 AKI.
AKI = Anti-Knock Index.



Do not use leaded fuels. The use of leaded fuels will cause permanent damage to the system's oxygen sensor and the catalytic converter. ◀

Wheels and tires

Tire inflation pressure

Information for your safety

It is not merely the tire's service life, but also driving comfort and – to a great extent – driving safety that depend on the condition of the tires and the maintenance of the specified tire pressure.

 Check the tire inflation pressure regularly and correct it if necessary, including the spare wheel: at least every two weeks and before beginning a longer trip. If you fail to observe this precaution you may be driving on tires with incorrect tire pressures, a condition that can not only compromise your vehicle's stability, but also lead to tire damage and the risk of an accident.

Do not drive with deflated, i.e. flat tires, except run-flat tires. A flat tire will seriously impair your vehicle's handling and braking response. Attempts to drive on a flat tire can lead to loss of control over the vehicle. ◀

Checking inflation pressure

Only check tire inflation pressure when the tires are cold. i.e. after a maximum of 2 hours' driving or when the vehicle has been parked for at least 2 hours. When tires are warm, the tire inflation pressure increases.

After correcting the inflation pressure(s), always reinitialize the Flat Tire Monitor, refer to page 95.

Inflation pressure for original tires



AN00772CM03



The inflation pressures for your standard tires can be found on the door pillar when you open the driver's door.

Inflation pressure for other tire sizes

The table below provides all the correct inflation pressures for the specified tire sizes at ambient temperature.



 For correct identification of the right tire inflation pressure for your tires, observe the specifications for the corresponding tire size. ◀

745i, 745Li

Tire size	Pressure specifications in psi/kPa			
All pressure specifications in the table are indicated in psi/kilopascal with cold tires. Cold = ambient temperature	max. 			
245/50 R 18 100 V M+S	32/220	35/240	35/240	42/290
245/55 R 17 102 W				
245/50 R 18 100 W				
245/55 R 17 102 Q M+S				
245/50 R 18 100 Q M+S				
Front: 245/45 R 19 98 W	32/220	-	35/240	-
Rear: 275/40 R 19 101 W	-	35/240	-	42/290
Front: 245/40 R 20 95 Y	32/220	-	35/240	
Rear: 275/35 R 20 98 Y	-	35/240	-	42/290

More details on the permitted load and weights can be found on page [214](#).

760Li

Tire size	Pressure specifications in psi/kPa			
All pressure specifications in the table are indicated in psi/kilopascal with cold tires. Cold = ambient temperature	max. 			
245/50 R 18 100 V M+S	35/240	38/260	38/260	42/290
245/50 R 18 100 W				
245/50 R 18 100 Q M+S				
Front: 245/45 R 19 98 Y	35/240	-	38/260	-
Rear: 275/40 R 19 101 Y	-	38/260	-	42/290
Front: 245/40 R 20 95 Y	35/240	-	38/260	
Rear: 275/35 R 20 98 Y	-	38/260	-	42/290

More details on the permitted load and weights can be found on page [214](#).

Tire identification marks

Knowledge of the labeling on the side of the tire makes it easier to identify and choose the right tires.

Tire size

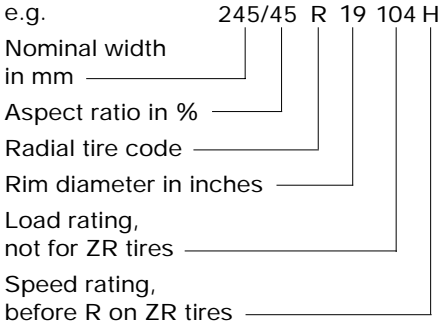

Speed rating

- Q = up to 105 mph/160 km/h
- T = up to 118 mph/190 km/h
- H = up to 131 mph/210 km/h
- V = up to 150 mph/240 km/h
- W = up to 167 mph/270 km/h
- Y = up to 186 mph/300 km/h

Tire Identification Number

Tires with DOT codes meet the guidelines of the U.S. Department of Transport.

DOT code:

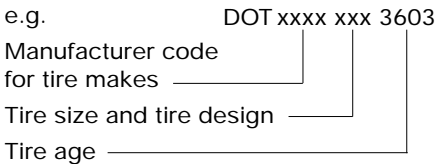

Tire age

The tire's date of manufacture is indicated on the sidewall:

DOT ... 3603 indicates that the tire was manufactured in the 36th week of 2003.

Regardless of mileage or wear, BMW recommends that you replace all tires – including the spare – after a maximum of 6 years,

even though the tires may have a theoretical service life of up to 10 years.

Uniform Tire Quality Grading

Quality grades can be found where applicable on the tire sidewall between tread shoulder and maximum section width.

For example:

Treadwear 200 Traction AA
Temperature A

DOT Quality Grades

Treadwear
Traction AA A B C
Temperature A B C



All passenger car tires must conform to Federal Safety Requirements in addition to these grades. ◀

Treadwear

The treadwear grade is a comparative rating based on the wear rate of the tire when tested under controlled conditions on a specified government test course.

For example, a tire graded 150 would wear one and one-half – 1½ – times as well on the government course as a tire graded 100. The relative performance of tires depends upon the actual conditions of their use, however, and may depart significantly from the norm due to variations in driving habits, service practices and differences in road characteristics and climate.

Traction

The traction grades, from highest to lowest, are AA, A, B, and C.

Those grades represent the tire's ability to stop on wet pavement as measured under controlled conditions on specified government test surfaces of asphalt and concrete. A tire marked C may have poor traction performance.



The traction grade assigned to this tire is based on straight-ahead braking traction tests, and does not include acceleration, cornering, hydroplaning, or peak traction characteristics. ◀

Temperature

The temperature grades are A – the highest –, B, and C, representing the tire's resistance to the generation of heat and its ability to dissipate heat when tested under controlled conditions on a specified indoor laboratory test wheel.

Sustained high temperature can cause the material of the tire to degenerate and reduce tire life, and excessive temperature can lead to sudden tire failure. The grade C corresponds to a level of performance which all passenger car tires must meet under the Federal Motor Vehicle Safety Standard No. 109. Grades B and A represent higher levels of performance on the laboratory test wheel than the minimum required by law.

 The temperature grade for this tire is established for a tire that is properly inflated and not overloaded. Excessive speed, underinflation, or excessive loading, either separately or in combination, can cause heat buildup and possible tire failure. ◀

Run-flat tires

You will recognize run-flat tires by a circular symbol containing the letters RSC on the side of the tire, refer to page 193.

M+S

Winter and all-season tires. These have better winter properties than summer tires.

Tire condition

Inspect your tires frequently for tread wear, signs of damage and for foreign objects lodged in the tread. Check the tread depth.

Tire tread

The tread depth should not fall below $\frac{1}{8}$ in/3 mm.

At tread depths below $\frac{1}{8}$ in/3 mm, there is an increased risk of high-speed hydroplaning, even when only small amounts of water are present on the road surface.

As winter tires display a noticeable loss in their ability to cope with cold-weather driving conditions once the tread wears to below $\frac{1}{6}$ in/4 mm, to ensure continued safety you should always have such tires replaced.

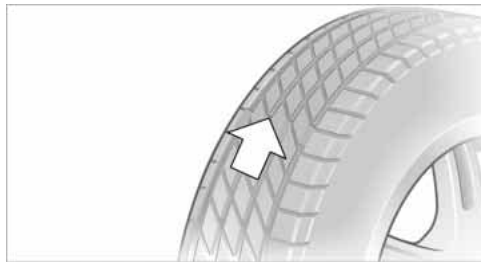

Wear indicators at the tread-groove base, refer to arrow, are distributed over the tire's circumference and are marked on the side of the tire with TWI – Tread Wear Indicator. These indicators signal at a tread depth of $\frac{1}{16}$ in/1.6 mm that the legally permitted wear limit has been reached.

Tire damage

 Unusual vibrations encountered during normal vehicle operation can indicate tire failure or some other vehicle defect. This can, for example, be caused by driving over curbs.

These kinds of problems may also be signaled by other changes in vehicle response, such as a strong tendency to pull to the left or right. Should this occur, respond by immediately reducing your speed. Carefully proceed – or have your vehicle towed – to the nearest BMW center or tire dealer to have the wheels or tires inspected.

Tire damage, extending to sudden and complete loss of pressure in extreme cases, can pose a potentially lethal safety hazard for the vehicle's occupants and other road users alike. ◀

Replacing wheels/tires

 Unprofessional attempts by laymen to service tires can lead to damage and accidents.

Have this work performed by skilled professionals only. The technicians at your BMW center will be glad to assist you with the required professional knowledge and specialized equipment. ◀

The correct wheel and tire combination affects various systems whose function would otherwise be impaired, e.g. ABS or DSC.

Have the wheel and tire assemblies balanced every time either a wheel or a tire is replaced.

 BMW does not recommend the use of retreaded tires, as otherwise driving safety may be reduced. Possible variations in the design and the age – which could be substantial – of the carcasses can lead to unusually rapid wear. ◀

The right wheels and tires

 BMW recommends that you use only wheel and tire combinations that BMW has tested and approved for your particular vehicle. Variations in factors such as manufacturing tolerances mean that even wheels and tires with identical official size ratings could actually have different dimensions than the approved units – these differences could lead to body contact, and with it the risk of severe accidents. If non-approved wheels and tires are used, BMW cannot evaluate their suitability, and therefore cannot be held liable for driving safety. ◀

To maintain good handling and vehicle response, use only tires of a single tread configuration from a single manufacturer. After a flat tire, always remember to have the original wheel and tire combination remounted on the vehicle as soon as possible.

Recommended tire brands

BMW tests certain tire brands for each tire size, classifies them as road-safe and approves them. You can find out about these at specialized dealers or at your BMW center. Observe any country-specific regulations, e.g. on making a corresponding entry in the vehicle documents.

The factory-mounted tires have been specially selected to provide optimized performance when installed on your vehicle; if properly cared for, they will provide a combination of safety and excellent ride comfort.

Run-flat tires

If your BMW is equipped with run-flat tires, refer to Run-flat tires, only use these tires, as in the event of a breakdown there is no spare wheel available.

Special characteristics of winter tires

BMW recommends winter tires for use in cold winter driving conditions. Although so-called all-season M+S tires provide better winter traction than summer tires, they generally fail to provide the same levels of cold-weather performance as winter tires.

When switching to winter tires, observe the description at Tire condition, and Replacing wheels/tires, refer to page 191.

Run-flat tires

If your BMW is equipped with run-flat tires, refer to Run-flat tires, only use these tires, as in the event of a breakdown there is no spare wheel available.

Observing speed ratings

 Never exceed the maximum speed for which the winter tires are rated. Unprofessional attempts by laymen to service tires can lead to damage and accidents. Have this work performed by skilled professionals only. The technicians at your BMW center will be glad to assist you with the required professional knowledge and specialized equipment. ◀

Storage

Always store wheels and tires in a cool, dry place with as little exposure to light as possible. Always protect tires against all contact with oil, grease and fuels.

Do not exceed the maximum tire inflation pressure indicated on the side wall of the tire.

Run-flat tires*



You will recognize run-flat tires by a circular symbol containing the letters RSC on the side of the tire. They consist of self-contained tires and special rims. The tire reinforcement ensures that the tire retains some residual safety in the event of pressure drop and driving remains possible to a restricted degree.

▶ If you switch from summer to winter tires, or vice versa, use run-flat tires, as in the event of a breakdown there is no spare wheel available. In this case, BMW recommends that you consult your BMW center. Your BMW center is qualified to handle run-flat tires and equipped with the necessary special tools. ◀

Continuing driving with a damaged tire

Driving on run-flat tires can continue, depending on the vehicle load and the severity of the tire damage, at a maximum speed of 50 mph/80 km/h.

In the case of complete inflation pressure loss, 0 psi/kPa, or obvious tire damage, you can estimate the possible distance for

continued driving on the basis of the following guide values:

- ▶ With low load:
 - 1 to 2 persons without luggage: Approx. 150 miles/250 km
- ▶ With medium load:
 - 2 persons, luggage compartment full, or 4 persons without luggage: Approx. 90 miles/150 km
- ▶ With full load:
 - More than 4 persons, luggage compartment full: Approx. 30 miles/50 km.

⚠ Drive reservedly and do not exceed a speed of 50 mph/80 km/h. With inflation pressure loss, the driving characteristics change, for example reduced track stability on braking, extended braking distance, and altered self-steering characteristics. ◀

Snow chains*

BMW only tests certain snow chains, classifies them as road-safe and approves them. Consult your BMW center for more information. BMW recommends only using these approved, narrow-link snow chains. These snow chains are approved exclusively for use in pairs on the rear wheels, and should only be mounted on tires with the dimensions 245/50 R 18. Observe the manufacturer's instructions when installing snow chains. Do not exceed a vehicle speed of 30 mph/50 km/h with the chains mounted.

▶ After mounting snow chains, do not activate the Flat Tire Monitor.

When you are driving with snow chains, it can be beneficial to switch off DSC briefly, refer to page 93. ◀

Under the hood

Hood

Releasing



Pull the lever located under the left side of the instrument panel.

⚠ Never attempt to perform any service or repair operations on your vehicle without the required, professional technical training. When you are unfamiliar with the service procedures and precautions, always have any required work carried out at your BMW center. Otherwise, the incorrect handling of parts and materials that can occur during such attempts constitutes a potential safety hazard, both for the vehicle's occupants and for other road users. ◀

Opening



Pull the release handle and open the hood.

Closing

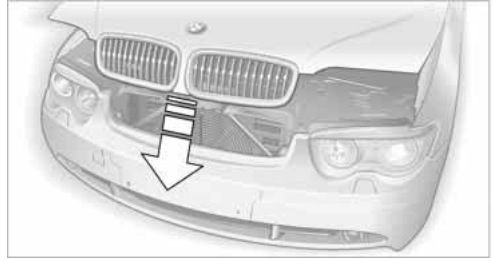

Close the hood from a height of approx. 16 in/40 cm with momentum. It must be clearly heard to engage.

⚠ Observe the same precautions that apply to all closing operations by ensuring that the hood's travel range is clear and unobstructed before allowing the hood to fall into position. If you see any signs that the hood is not completely closed while you are driving your vehicle, you should stop at once and close it securely. ◀

Engine compartment

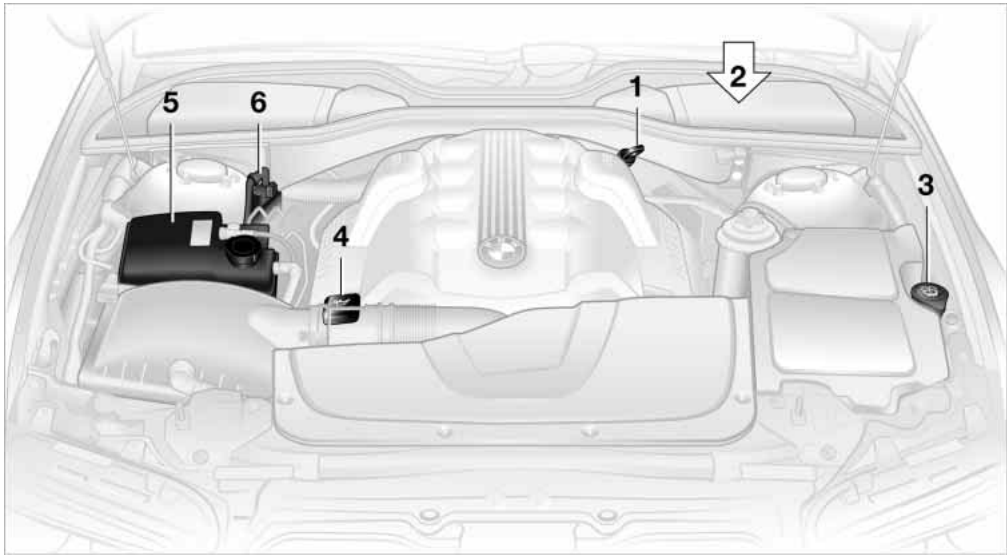

- 1 Engine oil dip stick, refer to [Checking oil level](#)
- 2 Brake fluid reservoir, located beneath the microfilter cover [197](#)
- 3 Reservoir for windshield and headlamp washer system [71](#)
- 4 Engine oil filler neck [196](#)
- 5 Coolant expansion tank [197](#)
- 6 Auxiliary terminal for jump-starting [207](#)

Engine oil

Checking oil level

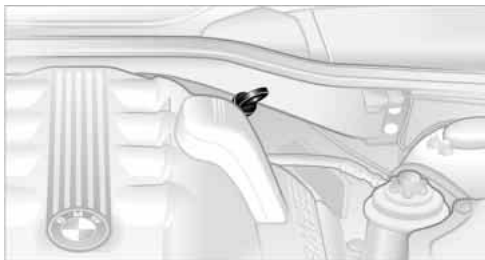

- 1. Park the vehicle on a level surface
- 2. Switch the engine off after it has reached normal operating temperature

- 3. After approx. 5 minutes, pull the dipstick out and wipe it off with a clean lint-free cloth, paper towel, or similar material
- 4. Carefully push the dipstick all the way into the guide tube and pull it out again
- 5. The oil should extend to between the two marks on the dipstick.

As is the case with fuel economy, the rate at which the engine uses oil is strongly influenced by driving style and operating conditions.

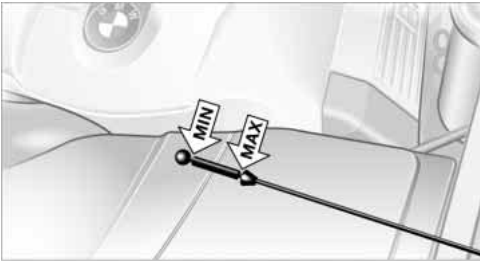

The oil quantity between the two marks of the dipstick is approx. 1.65 US quarts/ 1.5 liter. Do not fill beyond the upper mark on the dipstick. Excess oil can damage the engine.

Adding engine oil

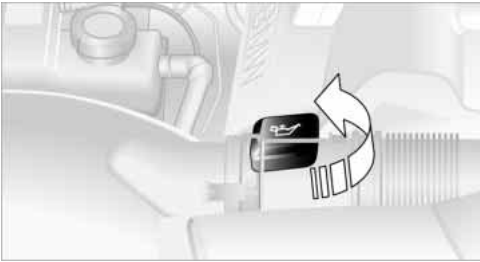

Wait until the level has dropped to just above the lower mark or a message appears in the Check Control before adding oil.

! BMW engines are designed to operate without additives, and their use could even lead to damage in some cases. This also applies to the automatic transmission, the differential and the power steering system. ◀

Recommendation: have your oil changed at your BMW center.

! Continuous exposure to used oil has caused cancer in laboratory testing. For this reason, any skin areas that come into contact with oil should be thoroughly washed with soap and water. Store oil, grease, etc., well out of the reach of children; always observe all warning labels on the containers. ◀

♻️ Always observe all applicable rules and regulations for environmental protection when disposing of used oil. ◀

Specified engine oils

The quality of the engine oil selected has critical significance for the operation and service life of an engine. BMW approves only specific oils after confirming their suitability for use in its vehicles with extensive testing.

Use only approved BMW High Performance Synthetic Oil.

If you are unable to obtain BMW High Performance Synthetic Oil, you can add small amounts of another synthetic oil between oil changes. Use only oils with the API SH specification or higher.

▶ Ask your BMW center for details concerning the specific BMW High Performance Synthetic Oil or synthetic oils which have been approved. ◀

You can also call BMW of North America at 1-800-831-1117 or visit this website: www.bmwusa.com to obtain this information.

Viscosity ratings

Viscosity is the oil flow rating as defined in SAE classes.

The selection of the correct SAE class depends on the climatic conditions in the area where you typically drive your BMW.

▶ Approved oils are in SAE classes 5W-40 and 5W-30. ◀

These oils may be used for driving in all ambient temperatures.

Coolant

! Do not add coolant to the cooling system when the engine is hot. Escaping coolant can cause burns. Antifreeze and anticorrosion agents are hazardous to health. Always store these agents in tightly-closed original containers kept well away from the reach of children.

Antifreeze and anticorrosion agents are flammable. Therefore, do not pour over hot engine parts, as otherwise they could catch fire and cause burns.

Always observe the instructions for use provided on the containers. ◀

 Always observe all applicable rules and regulations for environmental protection when disposing of used anti-freeze and anticorrosion agents. ◀

Checking coolant level

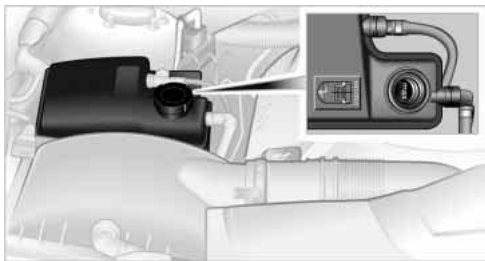

Correct coolant level with the engine cold – approx. +68 °F / 20 °C:

1. Turn the cap of the expansion tank counterclockwise to allow any accumulated pressure to escape, then continue turning to open
2. The coolant level is correct when the coolant extends to between the MIN and MAX marks on the filler neck, refer to the diagram adjacent to the filler neck
3. If the coolant is low, slowly add coolant up to the specified level – do not overfill.

Brake fluid

 The symbol lights up and a message appears in the Check Control: The brake fluid in the reservoir has fallen to below the minimum level.

The brake fluid reservoir is located under the microfilter housing trim panel on the driver's side of the vehicle. To have brake fluid added to the system, or to have the

source of any brake fluid loss traced and rectified, please contact your BMW center, which can also supply the factory-approved – DOT 4 – brake fluids.

 Brake fluid is hygroscopic: it absorbs moisture from the atmosphere over the course of time.

To ensure that the brake system continues to provide safe and reliable performance, remember to have the brake fluid changed every two years at the latest, refer to page 82 and to the Service and Warranty Information Booklet for US models or the Warranty and Service Guide Booklet for Canadian models.

Brake fluid is toxic and also damages vehicle paintwork. Always store these agents in tightly-closed original containers kept well away from the reach of children.

Do not spill the fluid and do not refill the brake fluid reservoir to beyond the MAX mark. Should it come into contact with hot engine components, the brake fluid could ignite and cause personal injury in the form of burns. ◀

 Always observe all applicable environmental rules and regulations when disposing of used brake fluid. ◀

 Warning lamp for Canadian models.

Brake hydraulic systems

A low brake-fluid level combined with longer-than-usual pedal travel could be a sign that one of the brake system's hydraulic circuits has failed.

 Proceed to the nearest BMW center. Remember that pedal travel may be increased, and there may also be a substantial increase in the amount of pedal pressure required to brake the vehicle. Please adapt your driving style accordingly. ◀

Maintenance

The BMW Maintenance System

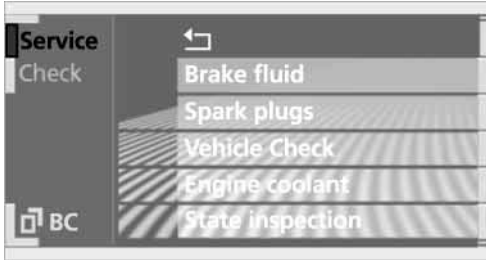

The BMW Maintenance System is designed to ensure that your vehicle will continue to furnish consistent reliability combined with optimized safety. The service schedule also includes operations related to the vehicle's comfort and convenience features, such as replacement of the filters for the inside air. The aim is to optimize maintenance with regard to reducing the cost of running the vehicle.

Should the day come when you decide to sell your BMW, you will find that a complete dealer service history is an asset of inestimable value.

CBS Condition Based Service

CBS is a more advanced version of the Service Interval Display. Sensors combine with highly-specialized algorithms to supply service information that reflects your vehicle's actual operating conditions more precisely than ever before.

The system now furnishes individual displays of the times remaining until the deadlines for specific service operations as well as official state inspections:

- ▷ Engine oil
- ▷ Brakes: separate for front and rear
- ▷ Microfilter/activated-charcoal filter
- ▷ Brake fluid
- ▷ Spark plugs

- ▷ Vehicle check
- ▷ Coolant
- ▷ Official state inspections.

CBS monitors both current and upcoming service requirements. After accessing the data stored in the vehicle's key, your BMW Service Advisor is able to suggest precisely the right array of service procedures for your own individual vehicle.

By letting you define a service and maintenance regimen that reflects your own individual requirements, Condition Based Service builds the basis for trouble-free driving.

You can find more detailed information on the Service Interval Display on page [81](#).

Service and Warranty Information Booklet for US models and Warranty and Service Guide Booklet for Canadian models

Please consult your Service and Warranty Information Booklet for US models and Warranty and Service Guide Booklet for Canadian models for additional information on service requirements.

- ▷ Have service and repair operations performed at your BMW center. Take the time to ensure that these service procedures are confirmed by entries in your vehicle's Service and Warranty Information Booklet for US models and Warranty and Service Guide Booklet for Canadian models. These entries verify that your vehicle has received the specified regular maintenance, and may also be required when submitting warranty claims. ◀

Care

You can find everything you need to know on this topic by consulting the separate Caring for your vehicle brochure.

Rules and regulations

California Proposition 65 Warning

California laws require us to issue the following warning:

 Engine exhaust and a wide variety of automobile components and parts, including components found in the interior furnishings in a vehicle, contain or emit chemicals known to the State of California to cause cancer and birth defects and reproductive harm. In addition, certain fluids contained in vehicles and certain products of component wear contain or emit chemicals known to the State of California to cause cancer and birth defects or other reproductive harm.

Battery posts, terminals and related accessories contain lead and lead compounds. Wash your hands after handling.

Used engine oil contains chemicals that have caused cancer in laboratory animals. Always protect your skin by washing thoroughly with soap and water. ◀

OBD connector



The Onboard Diagnostic OBD interface socket is located on the left of the driver's side under the instrument panel and under a cover.

The cover has the letters OBD on it.

The purpose of the OBD system is to ensure proper operation of the emission control system for the vehicle's lifetime. The system monitors emission-related components and systems for deterioration and malfunction.

 An indicator lamp informs you of the need for service, not of the need to stop the vehicle. However, the systems should be checked by your BMW center at the earliest possible opportunity.



Indicator lamp for Canadian models.

Under certain conditions, the indicator lamp will blink or flash. This indicates a rather severe level of engine misfire. When this occurs, you should reduce speed and consult the nearest BMW center as soon as possible. Severe engine misfire over only a short period of time can seriously damage emissions control components, especially the catalytic converter.

 When the fuel filler cap is not properly tightened, the OBD system can detect the vapor leak and the indicator will light up. If the filler cap is subsequently tightened, the indicator lamp should go out within a few days. ◀

Replacing components

Onboard tool kit

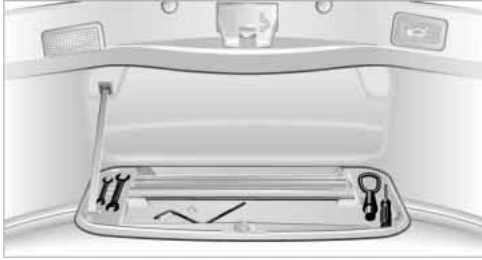

The onboard tool kit is located in the luggage compartment lid.

Loosen the wingnut to open.

The adapter for the spare key can be stored beneath the open-end wrenches.

Windshield wiper blades

To replace the blades, start by folding the wipers out and away from the windshield, refer to page 71.

Lamps and bulbs

The lamps and bulbs are essential factors contributing to the safety of your vehicle. Therefore, comply fully with the following instructions during bulb replacement. If you are not familiar with the specified procedures, BMW recommends having the replacements carried out at your BMW center.

▶ Never touch the glass of new bulbs with your bare fingers, as even minute amounts of contamination will burn into the bulb's surface and reduce its service life. Use a clean cloth, napkin, etc., or hold the bulb by its metal socket. ◀

You can obtain a selection of replacement bulbs at your BMW center.

⚠ To prevent short circuits, before working on any electrical system, equipment or accessory you should always switch it off and disconnect the cable from the battery's negative terminal before starting.

To avoid possible injury or equipment damage when changing bulbs, observe any instructions provided by the bulb manufacturer. ◀

▶ When maintaining the headlamps, please comply with the instructions in the separate Caring for your vehicle brochure. ◀

Headlamps

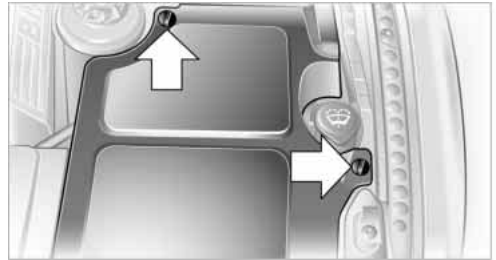

▶ For checking and adjusting headlamp aim, please contact your BMW center. ◀

Engine compartment, left side:
Turn the quick-release clamps 90° counterclockwise and remove the cover.

After replacing the bulb return the cover to its original position and press the quick-release clamps down.

Releasing the lamp cover

The illustration shows the left side of the engine compartment.

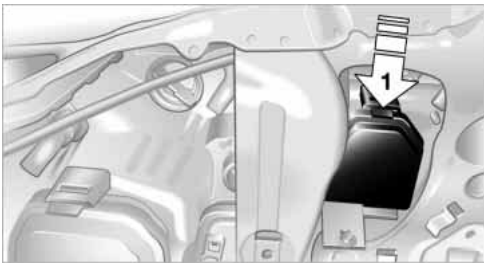

1 High beams

Press the tab down, refer to arrow.

! Always wear gloves and eye protection – the atmosphere within the bulb is pressurized. Failure to observe this precaution can lead to personal injury should the bulb be damaged. ◀

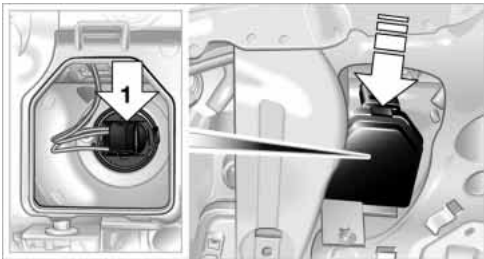

1 High beams

H7 bulb, 55 watts

1. Remove the cover
2. Turn the bulb holder to the left and remove
3. Remove and replace the bulb.

Xenon lamps

The service life of these bulbs is very long and the probability of a failure is very low, provided that they are not switched on and off an unusual number of times.

In the unlikely event that one of these lamps should fail, you can respond by switching on your fog lamps and proceeding carefully, where allowed by law.

! To avoid risk of potentially fatal injuries: owing to the extremely high voltages at which these units operate, service

work should always be entrusted to qualified personnel. ◀

Parking and standing lamps

In the event of a malfunction, please contact your BMW center.

Turn signal indicator, front

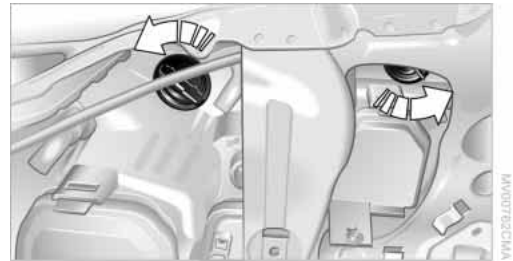

Two bulbs – 3457AK or 3457NAK*

1. Turn the bulb holder to the left and remove
2. Apply gentle pressure to the bulb while turning it to the left for removal and replacement.

Side-mounted turn signal indicators

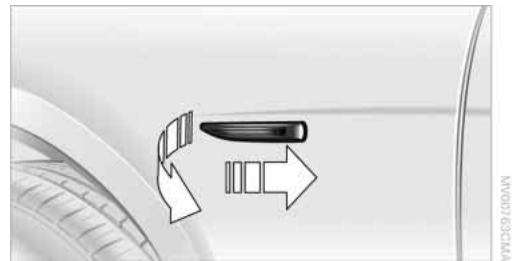

Bulb 5 watts – W 5 W

1. Press against the front edge of the lamp with the tip of your finger, then push it to the rear and release the detent at the front
2. Turn the lamp 90° and remove
3. Turn the bulb holder to the left and remove
4. Extract the bulb for replacement.

Side marker lamps, front and rear

Please contact your BMW center for replacement.

Tail lamps

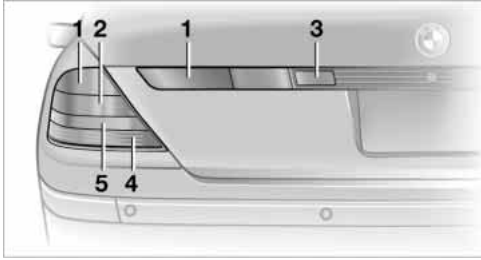

- 1 Rear lamp
- 2 Brake lamp
- 3 Backup lamp
- 4 Turn signal indicators
- 5 Reflector

Rear lamps and brake lamps

These lamps use LED technology for operation. Please contact a BMW center in case of a malfunction.

Fender-mounted lamps



The illustration shows the recess on the left side of the luggage compartment.

Rear turn signal indicator

Bulb 21 watts – P 21 W or PY 21 W*

1. Use the handle at the top to swivel down the side trim panel
2. Turn the bulb holder to the left and remove

3. Apply gentle pressure to the bulb while turning it to the left for removal and replacement.

Lamps in the luggage compartment lid

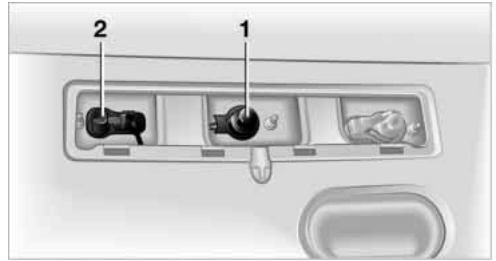

Remove the trim panel from the luggage compartment lid.

- 1 Backup lamp
- 2 License plate lamp

Backup lamps and license plate lamps

Backup lamp: bulb 16 watts – W 16 W

License plate lamp: bulb 5 watts – W 5 W

1. Pull the bulb holder out
2. Extract the bulb for replacement.

Changing wheels

⚠ Safety precautions to observe in the event of a flat tire and during all tire changes:

Park the vehicle as far as possible from passing traffic. Park on a firm, flat, surface. Switch on the hazard warning flashers. Engage the handbrake and move the transmission's selector lever to P.

Have all vehicle occupants get out of the vehicle and ensure that they remain outside the immediate area in a safe place, such as behind a guardrail.

If a warning triangle or portable hazard warning lamp is required, set it up on the roadside at an appropriate distance from the rear of the vehicle.

Comply with all safety guidelines and regulations.

Change the wheel only on a level, firm surface which is not slippery. The vehicle or the jack could slip to the side if you attempt to raise the vehicle on a soft or slippery surface such as snow, ice, tiles, etc.

Position the jack on a firm support surface. Do not use a wooden block or similar object as a support base for the jack, as this would prevent it from extending to its full support height and reduce its load-carrying capacity.

To avoid serious or fatal injury: never lie under the vehicle, and never start the engine while it is supported by the jack. ◀

What you will need

To avoid rattling noises, note the positions of the tools before removing them, then return them to their initial positions after completing work.

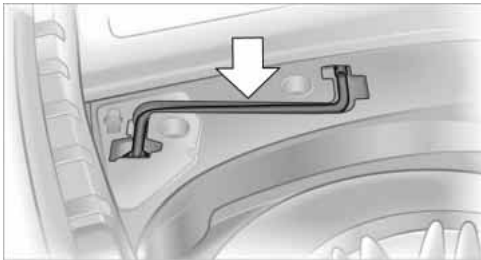

- ▷ Lug wrench
Located beside the spare tire



- ▷ Wheel chock
The chock is located next to the spare tire, or behind the trim panel on the left side of the luggage compartment on vehicles equipped with a trailer coupling.

Remove the floor mat and the cover above the spare tire.
Unscrew the wingnut and remove the wheel chock

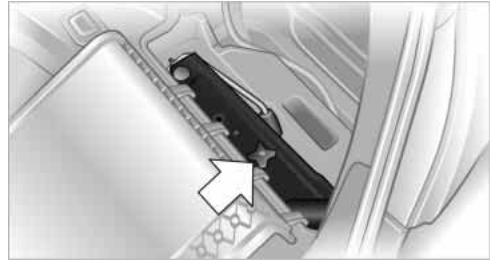

- ▷ Jack
The jack is located behind the side trim panel on the right side of the luggage compartment.
Grasp the handle in the upper panel and fold it down.
Unscrew the wingnut and remove the jack.
After use, screw the jack all the way back down and snap the handle back into place.

Spare tire

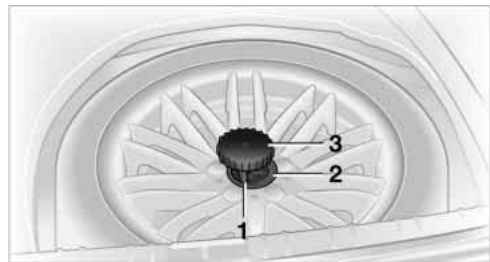

1. Unscrew wing nut 1
2. Remove disk 2 to the side
3. Completely unscrew threaded rod 3
4. Remove the wheel.

Procedure

1. Read carefully and comply with the safety precautions on page 203
2. Secure the vehicle to prevent it from rolling:
Place the wheel chock against the rear

surface of the front tire on the side opposite the side being raised. If the vehicle is parked on a downward slope, place the wheel chock securely in front of the tire. If the wheel must be changed on a surface with a more severe slope, take additional precautions to secure the vehicle from rolling

3. Loosen the lug bolts 1/2 a turn

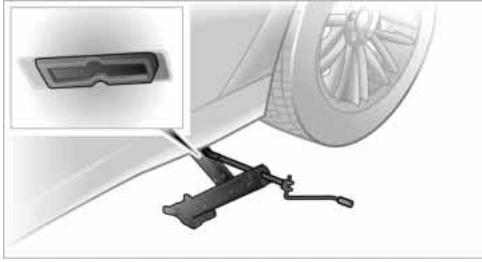

4. Set up the jack beneath the jacking point closest to the flat tire. Ensure that the entire surface of the jack's base is in firm contact with the ground and that the jack itself is standing completely vertical, not tilted, and that the fitting on the top of the jack will align with the rectangular recess on the vehicle when you raise it, refer to illustration
5. Jack the vehicle up until the wheel you are changing is raised from the ground
6. Unscrew the lug bolts and remove the wheel
7. Remove accumulations of mud or dirt from the mounting surfaces of the wheel and hub. Clean the lug bolts
8. Position the spare wheel. Secure the wheel by turning at least two lug bolts into opposite bolt holes
9. Screw in the remaining lug bolts. Tighten all the bolts securely in a diagonal pattern
10. Lower the jack and remove it from beneath the vehicle
11. Tighten the lug bolts in a diagonal pattern
12. Check and correct the tire inflation pressure at the earliest opportunity.

 Protect valve stems and valve stem seal caps against dirt and contamination. Dirt in valve stems is a frequent source of gradual air loss. ◀

After mounting the spare wheel or correcting the inflation pressure, reinitialize the Flat Tire Monitor, refer to page 95.

 The vehicle jack is designed for changing wheels only. Do not attempt to raise another vehicle model with it or to raise any load of any kind. To do so could cause accidents and personal injury. To ensure safety, always have the lug bolts checked with a calibrated torque wrench as soon as possible to ensure that they are tightened to the specified torque. The tightening torque is 101 ft-lb/ 140 Nm. ◀

Reverse the removal sequence to store the wheel and tools in the vehicle.

When you mount wheels other than Genuine BMW light-alloy wheels, different lug bolts may also be required.

Always have damaged tires replaced and the wheel and tire assembly rebalanced at the earliest possible opportunity.

Driving with the spare tire

 On certain wheel-tire combinations, the size of the spare tire deviates from that of the rest of the tires. The spare tire is fully capable of running in all load and speed ranges. However, to recreate the original conditions, the tire should be replaced as soon as possible. ◀

Run-flat tires*



You will recognize run-flat tires by a circular symbol containing the letters RSC on the side of the tire. They consist of self-contained tires and special rims. The tire reinforcement ensures that the tire retains some residual safety in the event of pressure drop and driving remains possible to a restricted degree. The vehicle is equipped with a Flat Tire Monitor which indicates punctures.

 The reinforcement on the flanks of the tires means that it is usually not possible to detect an air loss from outside. ◀

Flat tire

If you have a flat tire, the indicator lamp symbol in the Check Control will light up in red, and a message will appear. In addition, a gong sounds.

You can find more detailed information on the Flat Tire Monitor on page [95](#).

Reduce vehicle speed carefully to under 50 mph/80 km/h, avoiding hard brake applications and steering maneuvers.

If the defective wheel is not recognizable as such immediately, check the inflation pressure in all four tires.

 For reasons of safety, do not arrange for run-flat tires to be repaired. Your BMW center has the information needed for working with these tires and is equipped with the necessary special tools. ◀

Continuing driving with a damaged tire

Driving on run-flat tires can continue depending on the vehicle load and the severity of the tire damage, at a maximum speed of 50 mph/80 km/h. You can determine the possible mileage for continued driving on the basis of the following general indications:

- ▷ Tire inflation pressure 0 psi/kPa:
With empty vehicle approx. 90 miles/
150 km
With full payload approx. 30 miles/
50 km
- ▷ Tire inflation pressure 7 psi/50 kPa to 15 psi/100 kPa:
Approx. 300 miles/500 km
- ▷ Tire inflation pressure greater than 15 psi/100 kPa:
Approx. 600 miles/1,000 km.

 Drive reservedly and do not exceed a speed of 50 mph/80 km/h. In the case of air loss, you can expect changes in vehicle handling such as reduced lane stability, longer braking distances, and changes in self-steering properties. ◀

Battery

Battery care

The battery is 100% maintenance-free, i.e., the electrolyte will last for the life of the battery when the vehicle is operated in a temperate climate.

 For all questions that regard the battery, please consult your BMW center. ◀

Charging the battery

Only charge the battery in the vehicle via the terminals in the engine compartment with the engine off. Connections, refer to Jump-starting on page [208](#).

Battery switch

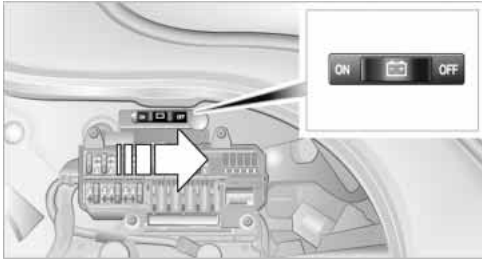

Before storing the vehicle for an extended period of several weeks or more, slide the battery switch located behind the trim panel on the right side of the luggage compartment to OFF. This reduces the current flow from the battery for the period during which the vehicle remains parked. A message appears in the Check Control. Please take note of the supplementary information provided on the Control Display.

Disposal



Return used batteries to a recycling point or your BMW center. Maintain the battery in an upright position for transport and storage. Always restrain the battery to prevent it from tipping over during transport. ◀

Fuses



Never attempt to repair a blown fuse, and do not replace a defective fuse with a substitute of another color or amperage rating, as this could lead to a circuit overload, ultimately resulting in a fire in the vehicle. ◀

Spare fuses are located on the fuse strip in the glove compartment; plastic tweezers can be found at the fuse holder in the luggage compartment.

In the glove compartment

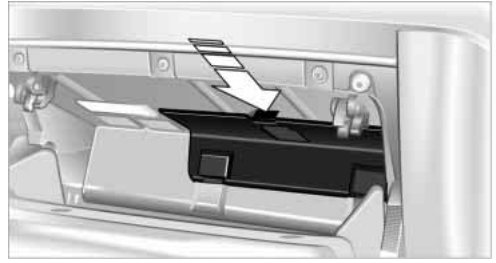

Press the tab on the cover to the front, then fold up the cover.

In the luggage compartment

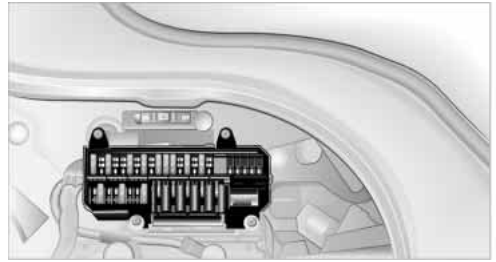

Use the handle to pull down the trim on the right wall.

Giving and receiving assistance

Warning triangle*



The warning triangle is conveniently stored in the onboard tool kit mounted on the inside of the luggage compartment lid.

 Comply with legal requirements requiring you to carry a hazard warning triangle in the vehicle. ◀

First-aid kit*

You will also find the first-aid kit in the onboard tool kit's container.

 Some of the articles contained in the first-aid kit have a limited service life. For this reason, check the expiration dates of each of the items regularly, and replace any whose expiration dates have passed. You can find replacements in any pharmacy.

Always comply with laws requiring a first-aid kit to be carried in the vehicle. ◀

Jump-starting

When your battery is discharged you can use two jumper cables to start your vehicle with power from the battery in a second vehicle. You can also use the same method to help start another vehicle. Use only jumper cables with fully-insulated clamp handles.

 To avoid the risk of potentially fatal injury, always avoid all contact with electrical components while the engine is running. Carefully adhere to the following sequence, both to prevent damage to one or both vehicles, and to guard against possible personal injury. ◀

Preparing

1. Check whether the battery of the other vehicle has a voltage of 12 Volts and approximately the same capacitance in Ah. This information can be found on the battery
2. Switch off the engine of the support vehicle
3. Switch off any electrical systems and components in both vehicles.

 Ensure that no contact exists between the bodywork on the two vehicles, otherwise there is a danger of short circuits. ◀

Connecting the jumper cables

 To avoid personal injury from sparks, always observe this sequence when connecting jumper cables. ◀

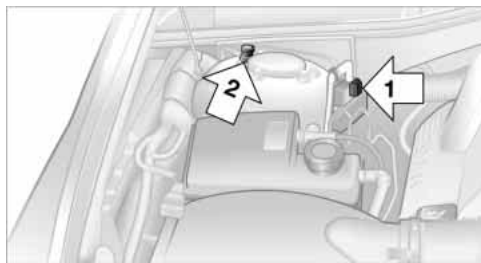

Your BMW is equipped with an auxiliary terminal specifically designed for jump-starting. It is located within the engine compartment, refer to arrow 1 in the illustration. The symbol + is embossed on the cover.

1. Remove the cover of the BMW auxiliary terminal for jump-starting
2. Connect one terminal clamp of the positive/+ jumper cable to the positive terminal of the battery or an auxiliary terminal for jump-starting of the vehicle providing starting assistance
3. Connect the second terminal clamp of the positive/+ jumper cable to the positive terminal of the battery or to an auxiliary terminal for jump-starting of the vehicle to be started

On your BMW, there is a special nut as body ground on the suspension strut dome, refer to arrow 2 in the illustration.

4. Attach one end of the negative/- jumper cable to the negative terminal of the battery or to an engine or body ground of the vehicle providing assistance
5. Connect the second terminal clamp of the negative/- jumper cable to the negative terminal of the battery or to the engine or body ground of the vehicle to be started.

Starting the engine

1. Start the engine on the support vehicle and allow it to run for several minutes at a fast idle
2. Start the engine on the other vehicle in the usual way.
If the first start attempt is not successful, wait a few minutes before another attempt in order to allow the discharged battery to recharge
3. Allow the engines to run for several minutes
4. Disconnect the jumper cables by reversing the connection sequence.

If required, have the battery inspected and recharged at your BMW center.

 Never use spray fluids to start the engine. ◀

Having vehicle towed

 Always observe all applicable towing laws and regulations.

Even if the transmission is in perfect working order, remember to disengage the transmission lockout manually before towing the vehicle. Failure to observe this precaution could result in automatic activation of the transmission lockout while the vehicle is being towed. ◀

Manual release of the transmission lockout, refer to page 68.

Towing with a commercial tow truck

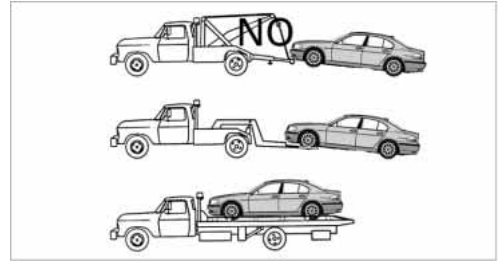

- ▷ Use a wheel lift or flatbed carrier
- ▷ Do not tow with sling-type equipment.

 Never allow passengers to ride in a towed vehicle for any reason. ◀

Towing with raised front axle

 Do not tow the vehicle by the rear axle; because the steering detent is not operational, the wheels could turn to an extreme angle during towing. ◀

1. Manual release of the transmission lockout, refer to page 68.
2. Towing speed:
Maximum of 45 mph/70 km/h
3. Towing distance:
Maximum of 90 miles/150 km.

Tow fitting

The threaded tow fitting is stored in the tool kit mounted on the inside of the luggage compartment lid, refer to page 200, and should always remain in the vehicle. It can be screwed in at the front or rear of the vehicle.

Access to tow sockets

Front

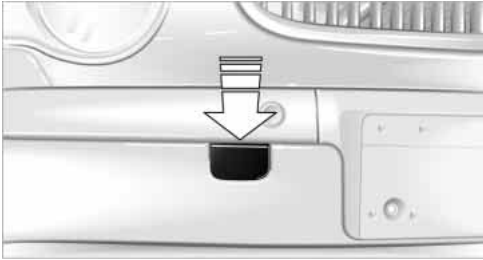

Rear

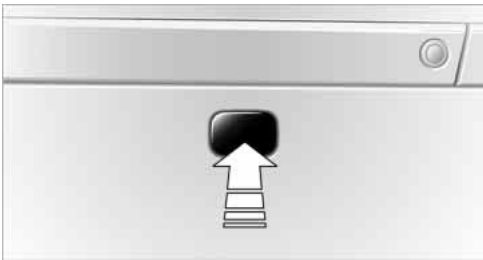

Press the arrow symbol to push out the cover.

⚠ Only use the tow fitting that comes with the vehicle and screw it in as far as it will go. Only use the tow fitting to tow on the roadway. Adhere to these specifications, as otherwise the tow fitting can be torn out and damage the vehicle. Never attempt to tow or tie down the vehicle using suspension components, as this could lead to damage that might ultimately result in an accident. ◀



Reference

This is where to look to find information on any desired topic as quickly as possible.

This chapter includes the section with technical data as well as the manual's index.

Technical data

Engine specifications

		745i, 745Li	760Li
Displacement	cu in/cm ³	268.4/4,398	364.4/5,972
Number of cylinders		8	12
Maximum output at engine speed	hp rpm	325 6,100	438 6,000
Maximum torque at engine speed	lb ft/Nm rpm	330/450 3,600	444/600 3,950
Compression ratio	ε	10.0	11.3
Stroke	in/mm	3.26/82.7	3.15/80.0
Bore	in/mm	3.6/92.0	3.50/89.0
Fuel-injection system	Digital electronic engine-management system		

Dimensions

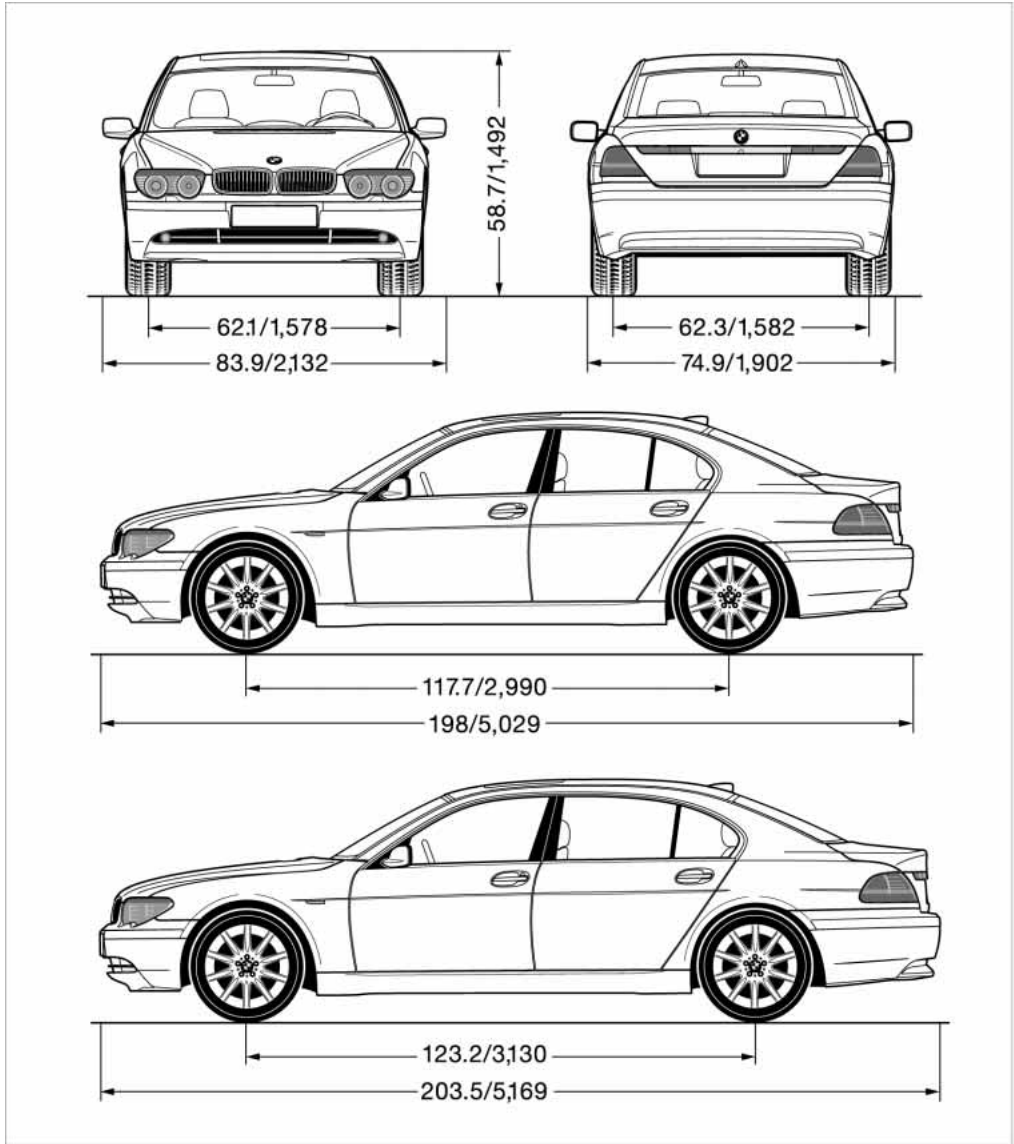

All dimensions specified in in/mm. Lower side view: Li models.
Min. turning circle dia.: 39.7 ft/12.1 m; Li models: 41.3 ft/12.6 m.

Weights

		745i	745Li
Curb weight	lbs./kg	4,376/1,985	4,464/2,025
Approved gross vehicle weight	lbs./kg	5,434/2,465	5,523/2,505
Load	lbs./kg	1,058/480	1,059/480
Approved front axle load	lbs./kg	2,557/1,160	2,602/1,180
Approved rear axle load	lbs./kg	2,987/1,355	3,020/1,370
Approved roof load capacity	lbs./kg	220/100	
Luggage compartment volume	cu ft/l	17.7/500	

		760Li
Curb weight	lbs./kg	4,872/2,210
Approved gross vehicle weight	lbs./kg	5,930/2,690
Load	lbs./kg	1,058/480
Approved front axle load	lbs./kg	2,833/1,285
Approved rear axle load	lbs./kg	3,109/1,410
Approved roof load capacity	lbs./kg	220/100
Luggage compartment volume	cu ft/l	17.7/500

Never exceed either the approved axle loads or the gross vehicle weight.

Capacities

			Notes
Fuel tank	gal./liters	approx. 23.3/88	Fuel specification: page 187
Reserve	gal./liters	approx. 2.6/10	
Windshield and headlamp washer system	quarts/liters	approx. 6.3/6.0	For details: page 71
Engine with oil filter renewal			BMW High Performance Synthetic Oil. Specifications: page 196
745i, 745Li	quarts/liters	8.5/8.0	
760Li	quarts/liters	9.0/8.5	
Automatic transmission and differential		-	Lifetime fluid, no fluid change required

Everything from A to Z

Index

A

- "ABC..." for
 - navigation 132, 133
- ABS Antilock Braking System 91
- ACC, refer to Active cruise control 73
- "ACCEPT" for
 - navigation 136, 143
- Accessories 6
- Activated-charcoal filter 108
- "Activation time" 109
- Active cruise control 73
 - malfunctions 79
 - selecting distance 76
- Active head restraints, front 47
- Active seat 51
- Active seat ventilation 50
- Adapter for spare key 32
- Adaptive Head Light 99
- Adding engine oil 195
- "Address book" 142
- Adjusting cooling capacity
 - of rear air conditioner 108
- Airbags 97
- Air conditioner in the rear 108
- Air distribution 103, 106
- Airing, refer to
 - Ventilation 105
- Air pressure, refer to Tire inflation pressure 188
- Air supply 104
 - rear air conditioner 108
- Air vent outlets 102
- AKI, refer to Fuel specifications 187
- Alarm system 39
 - avoiding unintentional alarms 40
- All-season tires 192
- "AM..." 148, 152, 154
- AM waveband 152
- Anchorage 125
- "ANGLE" for DVD mode 168
- Antifreeze 196
 - washer fluid 71
- Antifreeze protection
 - coolant 196
 - radiator 196
- Antilock Braking System ABS 91
- Anti-theft alarm system 33, 39
- Approved gross vehicle weight 214
- Aquaplaning, refer to Hydroplaning 122
- "Arrow display" for navigation 140
- "AS ADDRESS"
 - creating a directory 142
 - current position 143
 - destination entry 132, 134, 135
 - destination list 136
 - home address 142
 - last destinations 136
- "AS DEST."
 - creating a directory 142
 - destination entry 134, 135
 - home address 142
 - last destinations 136
- "AS DESTINATION"
 - creating a directory 142
- Ashtray 115
- Assistance window, refer to Control Center 22
 - help texts 22
 - status lines 23
- AUC Automatic recirculated-air control 104
- "Audio" 148, 152
- Audio 148
 - adjusting the tone 149
 - controls 148
 - switching on/off 149
 - volume 149
- "AUDIO" for DVD mode 168
- "AUTO", automatic climate control 106
- Automatic
 - air distribution 103
 - cruise control 71
 - curb monitor 54
 - headlamp control 99
 - luggage compartment lid control 34, 38
 - steering wheel adjustment 52
- Automatic car wash, refer to The Caring for your vehicle brochure
- Automatic climate control 102
 - automatic air distribution 103
 - rear air conditioner 108
 - rear cooler 113
 - settings in Control Center 106
- Automatic Hold
 - parking 63
 - parking brake 63
- Automatic recirculated-air control AUC 104
- Automatic transmission with Steptronic 66
 - manual operation 67
 - sport program 67
- "AUTO P" 53, 63

"AUTOSTOR" 163
"Autostore" for radio mode 154
Average fuel consumption 85
Average speed 85
"Avoid highway" 137
Avoiding unintentional alarms 40
"Avoid route" 141
"Avoid sect." 140
"Avoid tolls" 137
"A-Z", telephone 179

B

Backrest adjustment 45, 46
Backrests, refer to Seats 44
Backup lamps, replacing bulbs 202
Balance 149
"Balance" for audio mode 150
Bass 149
"Bass" for audio mode 150
Battery 205
– flat 207
Battery switch 205, 206
"BC", refer to Computer 86
Belts 49
Beverage holders 115
Blinds 112
"BMW Assist" 21, 182
BMW Assist 182
"BMW Services" 182
Brake Assistant, refer to DBC Dynamic Brake Control 93
Brake fluid 197
Brake force display 96
Brake hydraulic systems 197
Brake lamps, replacing bulbs 202
Brake pads 123
Brakes 123
– malfunctions 197
Breaking in the vehicle 122

Break-in procedures 122
"Brief info" 22
"Brightness"
– for TV mode 164
– in the Control Center 89
Buttons on the steering wheel 16
– automatic transmission with Steptronic 66

C

California Proposition 65 Warning 199
Call
– ending 179
Calling 179
– from phone book 179
– from the redial list 180
– from the Top 8 list 180
– redialing 180
Can holder, refer to Beverage holders 115
Capacities 215
"Car data" 18, 21
Care, refer to the Caring for your vehicle brochure
Cargo, securing 125
Cargo area
– locking separately 37
Cargo loading 125
Caring for the vehicle finish, refer to the Caring for your vehicle brochure
Car phone 175, 178
– refer to separate Owner's Manual
Car radio, refer to Radio 148
Car wash 122
– refer to the Caring for your vehicle brochure
CBC Cornering Brake Control 91
CBS Condition Based Service 198
"CD" 148, 158
CD changer 160
– adjusting the tone 149
– controls 148
– fast forward 161
– random play 161
– reverse 161
– sampling 161
– Scan 161
– selecting CD 161
– selecting track 162
– skipping tracks 161
– switching on 160
– volume 149
CD player 158
– adjusting the tone 149
– controls 148
– fast forward 159
– random play 158
– reverse 159
– sampling 158
– Scan 158
– selecting tracks 158
– skipping tracks 158
– switching on 158
– volume 149
"Center" 107
Center armrest
– individual button assignment 17
Center brake lamp, refer to Brake lamps 202
Center console, refer to Comfort features 14
Central locking system 33
– button 37
– Comfort Access 34
– keys 36
– remote control 33
"CHANGE" for navigation 136
Changing a tire 203
Changing language 88
Changing settings on the Control Display 88
Changing the display format on the Control Display 88
Changing units of measure on the Control Display 88

- Check Control 82
 - "Check" 83
 - Checking engine oil level 195, 195
 - Checking inflation pressure 188
 - Child's seat 56
 - Child-restraint system 56
 - Child-safety lock 58
 - Cigarette lighter 116
 - Cleaning, refer to the
 - Caring for your vehicle brochure
 - Cleaning windshield 70
 - "Climate" 18, 21
 - "Clock" 88
 - Clock 80
 - setting time and date 88
 - Closing
 - from inside 36
 - from outside 33
 - Closing assist
 - doors 37
 - luggage compartment lid 38
 - Cockpit 10, 14
 - Coin holder, refer to front center armrest 114
 - Cold start 61
 - "Color" for TV mode 164
 - "Comfort"
 - "EDC" 94
 - Comfort Access 34
 - battery changing 35
 - Comfort features 14
 - Comfort seat 45
 - in rear 46
 - "Comm." 24
 - "Communication" 18, 21, 175
 - Compact Disc, refer to CD 158
 - Compartments, refer to Storage compartments 114
 - Computer, refer to Control Center 17, 84
 - automatic climate control 106
 - "BC" 86
 - changing settings 88
 - display, menus 21
 - displays on the Control Display 85
 - language selection 88
 - setting brightness 89
 - setting time and date 88
 - status lines 23
 - symbols 19
 - Condition Based Service CBS 198
 - Confirming a menu item on the Control Display 18
 - Connecting car vacuum cleaner 116
 - Consumption display 84, 85
 - "Contrast" for TV mode 164
 - Control Center 17
 - adjusting the brightness 89
 - assistance window 22
 - automatic climate control 106
 - changing settings 88
 - changing the menu page 19
 - display, menus 21
 - displaying help texts 22
 - language selection 88
 - lists 19
 - menus 21
 - rear 23
 - selecting units of measure and display format 88
 - setting time and date 88
 - status lines 23
 - symbols 19
 - symbols and lists 19
 - Control Display 17, 18
 - in the rear 23
 - switching off 18
 - Controller, refer to Control Center 17
 - Controls 10, 14
 - Convenience operation of windows and glass roof 36
 - Convenience starting feature 61
 - "Coolant" 198
 - Coolant 195, 196
 - Cooler, refer to Rear cooler 113
 - Country of destination 133
 - Courtesy lighting 101
 - Creating voice address book 142
 - Cruise control 71
 - active cruise control 73
 - Cruising range 85
 - Cup holder, refer to Beverage holders 115
 - Curb weight 214
 - Current fuel consumption 85
- ## D
- Data 212
 - "Date" 88
 - Daytime driving lamps 99
 - DBC Dynamic Brake Control 93
 - Defrosting the windshield, refer to Defrosting windows 104
 - Defrosting windows 104
 - Defrost setting 104
 - "DELETE" for navigation 136, 137
 - Destination 133
 - Destination during navigation
 - selecting in Information 135
 - selecting using voice 143
 - Destination entry 132
 - Destination guidance
 - interrupting 141
 - terminating 141
 - Destination list 136
 - "Dest. input" 132
 - "Detour" 141

Dialed numbers 180
Digital coverage area for navigation 130
Dimensions 213
Dipstick, engine oil 195
Direction
– arrow 140
– to destination 139
– voice instructions 141
Directional indicators, refer to Turn signal indicators 69
Disc brakes 123
Displacement 212
Display
– Control Center 21
– Control Display 17
Display illumination 100
Display lighting, refer to Instrument illumination 100
Display of faults 82
Displays 12
Disposal, battery 35
Distance 85
Distance tempomat, refer to Active cruise control 73
Distance to destination 85
Distance warning, refer to Park Distance Control 90
Door entry lighting 101
Door keys 32
Doors
– child-safety lock 58
– locking and unlocking 33
– manual operation 36
– remote control 33
DOT Quality Grades 190
Draft-free ventilation 105
Driving stability control 92
Driving tips 122
"DSC" 93
DSC Dynamic Stability Control 92
"DTC" 92
DTC Dynamic Traction Control 13, 92
"DVD" 148, 166

DVD changer 165
– adjusting the picture 168
– adjusting the tone 149
– controls 148
– country codes 166
– DVD controller 166
– fast forward 167
– freezing frame 168
– humidity 170
– reverse 167
– searching for chapter 167
– selecting a track 167
– selecting camera angle 169
– selecting DVD 167
– selecting language 168
– selecting picture format 168
– selecting subtitles 168
– specific menu 169
– switching on 166
– temperature range 170
– volume 149
DVD Multimedia changer, refer to DVD changer 165
Dynamic Brake Control DBC 93
Dynamic Drive 94
Dynamic Stability Control DSC 92
Dynamic Traction Control DTC 92

E

EBV Electronic brake-force distribution 91
"EDC" 94
– "Comfort" 94
– "Sport" 94
EDC Electronic Damping Control 94

Electrical malfunction
– automatic transmission lockout 68
– fuel filler door 186
– glass roof 43
– parking brake 65
Electric power seat 45, 46
Electric power windows 41
Electric steering wheel adjustment 52
Electronic brake-force distribution EBV 91
Electronic Damping Control EDC 94
Electronic toll collection device, refer to Entry/pass tags 126
Emergency call
– starting 177
– using button 177
Emergency operation
– automatic transmission lockout 68
– doors 36
– fuel filler door 186
– glass roof 43
– luggage compartment lid 39
– parking brake 65
Emergency release of luggage compartment lid from luggage compartment's interior 39
"Emissions inspection" 82
Energy-conscious driving, refer to Energy Control 85
Energy Control 85
Engine compartment 195
Engine coolant 195, 196
"Engine oil" 198
Engine oil
– consumption 195
– engine oil grades 196
– engine output 212
– engine specifications 212
"Entertainm." 24
"Entertainment" 18, 21, 148
Entry/pass tags 126

Environmentally friendly driving, refer to Energy Control [85](#)
 Equalizer [149](#), [150](#)
 ESP, refer to DSC [92](#)
 Extended vehicle storage, refer to the Caring for your vehicle brochure
 Exterior mirrors [51](#)
 – automatic dimming feature [51](#)
 "Extra"
 – in "Climate" menu [106](#)
 – rear air conditioning [109](#)
 – rear cooler [113](#)

F

Factory preparations for phone installation [177](#)
 Fader [149](#)
 "Fader" for audio mode [150](#)
 Failure messages, refer to Check Control [82](#)
 Failure of a current consumer [206](#)
 Fan, refer to Air supply [104](#)
 "Fastest route" [137](#)
 Fastest route [137](#)
 Filling the washer reservoir [71](#)
 Filling the windshield washer reservoir [71](#)
 First-aid kit [207](#)
 Fittings, towing [209](#)
 Flashlight [114](#)
 Flat Tire Monitor [95](#)
 Flat tires [188](#), [191](#)
 "FM..." [148](#), [152](#), [154](#)
 FM waveband [152](#)
 Fog lamps [100](#)
 "Footwell" [107](#)
 Footwell lamps [101](#)
 Front armrest, refer to Front center armrest [114](#)
 Front center armrest [114](#)
 Front seat adjustment [44](#)
 Front-to-rear adjustment in audio mode [149](#)

"FTM" [95](#)
 Fuel [187](#)
 Fuel capacity [186](#)
 Fuel economy [86](#)
 Fuel filler door [186](#)
 – releasing in the event of electrical defect [186](#)
 Fuel gauge [85](#)
 Fuel-saving driving, refer to Energy Control [85](#)
 Fuel specifications [187](#)
 Fuel tank capacity [186](#)
 "FULL MENU" [167](#), [168](#)
 "Full Release" [24](#)
 Fuses [206](#)

G

Garage door opener, refer to Integrated universal remote control [111](#)
 Gasoline [187](#)
 Gear changes, refer to Automatic transmission with Steptronic [66](#)
 Gearshifts, refer to Automatic transmission with Steptronic [66](#)
 General driving notes [122](#)
 Glasses compartment [115](#)
 Glass roof, electrical [42](#)
 – closing in the event of an electrical malfunction [43](#)
 – convenience operation [36](#)
 – remote control [34](#)
 Glove compartment [114](#)
 GPS, refer to Navigation system [130](#)

H

Hand lamp [114](#)
 Hands-free microphone [177](#)
 Hands-free system [177](#)
 Having vehicle towed [208](#)
 Hazard warning flashers [14](#)
 Headlamp control, automatic [99](#)
 Headlamp flasher [69](#)
 Headlamp washers [70](#)

Headlamp washer system [71](#)
 Head Light, refer to Adaptive Head Light [99](#)
 Head restraints [47](#)
 – front head restraints, active [47](#)
 Heated seats [49](#)
 Heated steering wheel [52](#)
 Heating and ventilation [102](#)
 Heating while stopped [105](#)
 Height [213](#)
 Height adjustment
 – seats [45](#)
 – steering wheel [52](#)
 "Help" [18](#), [21](#)
 Help texts in Control Display [22](#)
 High beams [100](#)
 – replacing bulbs [201](#)
 Home address [142](#), [143](#)
 Horn [11](#)
 "Hotline" [182](#)
 Hydraulic brake assistant, refer to DBC [93](#)
 Hydroplaning [122](#), [191](#)

I

Ice warning [80](#)
 iDrive, refer to Control Center [17](#)
 Ignition key [32](#)
 Ignition lock [60](#)
 – with Comfort Access [60](#)
 Independent ventilation [109](#)
 "Indep. ventil." [109](#)
 Indicator lamps [12](#)
 "Individual" [107](#)
 Individual button assignment [17](#)
 – on steering wheel [52](#)
 Inflation pressure [188](#)
 Info Display [12](#)
 "Information" for navigation [135](#), [136](#)
 Information on the navigation system, refer to Voice guidance for navigation [141](#)

Infrared windshield, refer to Entry/pass tags [126](#)
Instrument cluster, refer to Info Display [10](#), [12](#), [14](#)
Instrument cluster switch [70](#)
Instrument illumination [100](#)
Integrated universal remote control [111](#)
– malfunctions, refer to Entry/pass tags [126](#)
Interior lamps [100](#)
– remote control [34](#)
Interior mirror
– automatic dimming feature [51](#)
Interior motion sensor [41](#)
– switching off [34](#), [41](#)
Interior rearview mirror [51](#)
Intermittent operation for window wiper, refer to Rain sensor [70](#)

J

Joystick
– refer to Control Center [17](#)
– refer to Controller [17](#)
Jump-starting [207](#)

K

Keyless Go, refer to Comfort Access [34](#)
Keyless opening and closing, refer to Comfort Access [34](#)
Key Memory [54](#)
Keys [32](#)
– adapter for spare key [32](#)
Kickdown [67](#)

L

Language control [16](#), [25](#)
"Last" [180](#)
"Last dest." [136](#)
"Last exit" [141](#)
Latch, refer to LATCH child-restraint fixing [58](#)

LATCH child-restraint fixing [58](#)
LEDs light-emitting diodes [101](#)
"Left"
– for automatic climate control [106](#)
– for seat heating [50](#)
Length [213](#)
Level control system [96](#)
License plate lamp, replacing bulbs [202](#)
Light-emitting diodes LEDs [101](#)
Lighter [116](#)
Lighting of instruments [100](#)
Lights on warning [99](#)
Light switch [99](#)
"Limit" [86](#)
"Limited Release" [24](#)
Limit selection, adjustment [86](#)
Lists, Control Center [19](#)
Litter container [114](#)
Loading the vehicle [125](#)
"Location" [135](#), [142](#), [143](#)
Lock code [178](#)
Locking without key, refer to Comfort Access [34](#)
"LOGIC7" for audio mode [150](#)
Louvers [102](#)
Low beams [99](#)
– automatic [99](#)
Lower back support, refer to Lumbar support [46](#)
Lug bolts [204](#)
Luggage compartment
– Comfort Access [35](#)
– opening from the inside [38](#)
– operating via remote control [34](#)

Luggage compartment lid
– automatic [34](#), [38](#)
– Comfort Access [35](#)
– emergency operation [39](#)
– emergency release [39](#)
– locking separately [37](#)
– opening from the inside [38](#)
– opening from the outside [37](#)
– operating via remote control [34](#)
Luggage compartment net [39](#)
Luggage compartment volume [214](#)
Luggage rack, refer to Roof-mounted luggage rack [125](#)
Lumbar support [46](#)

M

M+S tires [192](#)
Maintenance [198](#)
Make-up mirror [51](#)
Malfunction displays [82](#)
Manually controlled recirculated air [104](#)
Manual operation
– automatic transmission [67](#)
– automatic transmission lockout [68](#)
– doors [36](#)
– fuel filler door [186](#)
– glass roof [43](#)
– luggage compartment lid [39](#)
– parking brake [65](#)
Manual release of transmission lockout [68](#)
Map CD/DVD [130](#)
"Map dir. travel" for navigation [140](#)
"Map facing N" [139](#)
"Map facing N." for navigation [140](#)
Maximum axle loads [214](#)
Maximum roof weight [214](#)

Maximum speed, refer to
 Limit [86](#)
 "Memo" [88](#)
 Memory, refer to Seat,
 mirror and steering wheel
 memory [53](#)
 "MENU" for DVD mode [169](#)
 "Menu name" [22](#)
 Menus
 - computer [21](#)
 - Control Display [21](#)
 "MFL" [52](#)
 "Microfilter" [198](#)
 Microfilter [108](#)
 Microphone for hands-free
 system [177](#)
 Mirrors [51](#)
 - dimming feature [51](#)
 - heating [51](#)
 - memory [53](#)
 "Missed" [181](#)
 Missed calls [181](#)
 Modifications, technical [6](#)
 Monitor, refer to Control
 Center [17](#)
 Monitor, refer to Control
 Display
 - in the rear [23](#)
 - switching off [18](#)
 Most frequently called
 numbers [180](#)
 Most recent portable phone
 numbers [180](#)

N

"Name" for navigation [133](#)
 "Navigation" [18](#), [21](#), [131](#)
 Navigation computer
 - installation location [130](#)
 Navigation destination
 - manual entry [132](#)
 - selecting from the
 directory [134](#)

Navigation system [130](#)
 - current position [143](#)
 - destination entry [132](#)
 - destination guidance in
 assistance window [131](#)
 - destination list [136](#)
 - digital coverage area [130](#)
 - directory [134](#)
 - manual entry of
 destination address [132](#)
 - map CD/DVD [130](#)
 - new route [140](#)
 - recent destinations [136](#)
 - route display [139](#)
 - route list [140](#)
 - route selection [137](#)
 - selecting destination in
 "Information" [135](#)
 - selecting points of
 interest [135](#)
 - selection options [132](#)
 - starting [131](#)
 - starting destination
 guidance [139](#)
 - switching off, refer to
 Terminating/interrupting
 destination guidance [141](#)
 - terminating/interrupting
 destination guidance [141](#)
 - town and city centers [144](#)
 - voice guidance [141](#)
 - volume adjustment [141](#)
 - wordmatch principle [138](#)
 "Navi info." [52](#)
 "New dest." [132](#)
 "New route" [140](#)
 "Next"
 - looking for interesting
 destinations [136](#)
 - selecting destination via
 map [135](#)
 "None Release" [24](#)
 Notebook of voice
 command system [27](#)
 Nozzles [102](#)
 NTSC during TV mode [164](#)

O

OBD connector [199](#)

Occupant-restraint
 systems [49](#), [97](#)
 Odometer [80](#)
 Oil additives [196](#)
 Oil change intervals, refer
 to Service Interval
 Display [81](#)
 Oil consumption [195](#)
 Oil dipstick [195](#)
 Oil grades [196](#), [196](#)
 "OK" for DVD mode [169](#)
 "ON / OFF" speed limit [87](#)
 Onboard Diagnostic OBD
 interface socket [199](#)
 Onboard tool kit [200](#)
 "On country" [136](#)
 "1,2,3" [179](#)
 "On location" [135](#)
 "On town/city" [136](#)
 Opening and closing
 - from inside [36](#)
 - from outside [36](#)
 Opening without key, refer
 to Comfort Access [34](#)
 Operating temperatures
 - in radio mode [148](#)
 Oral note [27](#)
 Orientation
 - changing the display [140](#)
 Orientation menu [18](#)
 Orientation to north [140](#)
 Outside temperature
 display [80](#)

P

PAL during TV mode [164](#)
 Panic mode [34](#)
 Park detent, refer to
 Transmission
 lockout [67](#), [68](#)
 Park Distance Control
 PDC [90](#)
 Parking aid [90](#)
 Parking brake [62](#)
 - Automatic Hold [63](#)
 - manual operation [65](#)
 Parking lamps [99](#)
 - replacing bulbs [201](#)

Parking the vehicle [61](#)
Parking with
 Automatic Hold [63](#)
Passenger-side mirror tilt
 function [54](#)
Pathway lighting [99](#)
"PDC image" [91](#)
PDC Park Distance
 Control [90](#)
Personal Calling [175](#)
"Perspective" for
 navigation [139](#)
Phone book [179](#)
 - creating voice command
 phone book [179](#)
 - deleting all entries [180](#)
 - dialing numbers [179](#)
 - dialing numbers using
 voice command
 system [180](#)
 - entering numbers in voice
 command phone
 book [179](#)
 - entry deletion [180](#)
 - updating voice command
 phone book [179](#)
 - viewing entries [180](#)
Phone number, refer to
 Portable phone [179](#)
"Pict. format" [168](#)
"Picture" [148](#)
 - DVD changer [168](#)
 - TV [164](#)
Please fasten safety belt
 warning lamp [49](#)
Pollen [108](#)

Portable phone
 - adjusting volume [177](#)
 - battery [175](#)
 - calling [179](#)
 - call termination [179](#)
 - codes [178](#)
 - controlling with the
 buttons on the steering
 wheel [16](#)
 - hands-free system [177](#)
 - missed calls [181](#)
 - operating using the
 Control Center [175](#)
 - redialing [180](#)
 - refer to separate portable
 phone Owner's Manual
 - selecting phone
 numbers [179](#)
 - switching on/off [178](#)
 - Top 8 list [180](#)
Power rating [212](#)
Power socket [116](#)
Power windows [41](#)
Pressure, tires [188](#)
Pressure monitoring,
 tires [95](#)
Programmable cruise
 control [71](#)
Programming settings,
 refer to Vehicle Memory,
 Key Memory [54](#)
Puncture
 - Flat Tire Monitor [95](#)

R

Radio
 - adjusting the tone [149](#)
 - "AUTOSTORE" [154](#)
 - Autostore [154](#)
 - controls [148](#)
 - memory locations [153](#)
 - operating
 temperatures [148](#)
 - sampling [153](#)
 - Scan [152](#)
 - selecting the
 waveband [152](#)
 - station search [152](#)
 - station selection [154](#)
 - storing a station [154](#)
 - switching on [152](#)
 - volume [149](#)
 - Weather Band [155](#)
Radio mode [60](#)
 - with Comfort Access [60](#)
Rain sensor [70](#)
Reading lamps [101](#)
"Rear" [24](#)
Rear air conditioner [108](#)
 - activation and
 deactivation in Control
 Center [109](#)
 - air supply [108](#)
 - cooling adjustment [108](#)
Rear armrest, refer to Rear
 center armrest [117](#)
Rear center armrest [117](#)
Rear cooler [113](#)
Rear lamps, replacing
 bulbs [202](#)
Rear monitor, refer to
 Control Center in rear [23](#)
Rear screen [23](#)
Rear seat heaters [50](#)
Rear seats
 - adjusting passenger seat
 from the rear [46](#)
 - comfort seat
 adjustments [46](#)
 - head restraint
 adjustment [47](#)
Rearview mirror [51](#)

- Rear window blind, refer to
 - Sun blinds [112](#)
 - Rear window defroster [14](#)
 - Rear window safety switch [10](#), [42](#)
 - "Recirc." [52](#)
 - Reclining seat [44](#)
 - Redialing with portable phone [180](#)
 - Redial list [180](#)
 - Refueling [186](#)
 - "Release" [24](#)
 - Releasing the engine hood [194](#)
 - Remote control [32](#), [33](#)
 - Comfort Access [34](#)
 - malfunctions [35](#)
 - Removing condensation from windows [104](#)
 - Replacement fuses [206](#)
 - Replacement keys [33](#)
 - Replacement tire [203](#)
 - Replacing light bulbs [200](#)
 - Replacing tires [192](#)
 - Reserve warning [85](#)
 - Reset [149](#)
 - "RESET" for audio mode [151](#)
 - Residual heat [105](#)
 - "Right"
 - for automatic climate control [106](#)
 - for seat heating [50](#)
 - Right/left balance adjustment in audio mode [149](#)
 - "RND"
 - CD changer [161](#)
 - CD player [158](#)
 - "Roadside Assistance" [182](#)
 - Roller sun blinds for rear side windows [112](#)
 - Roof-mounted luggage rack [125](#)
 - "Route" [140](#)
 - Route
 - display [139](#)
 - list [140](#)
 - map cancellation [140](#)
 - new [140](#)
 - selecting [137](#)
 - "Route guid." [139](#), [141](#)
 - Route map [140](#)
 - "Route selec." [137](#)
 - Route selection [137](#)
 - Run-flat tires [192](#), [205](#)
- ## S
- Safety belts [49](#)
 - Safety belt tensioners, refer to Safety belts [49](#)
 - Safety lock buttons [37](#)
 - Sampling scan
 - CD [158](#)
 - radio [153](#)
 - "Save"
 - "Individual" [107](#)
 - "Save dest." [135](#)
 - "SCAN"
 - CD changer [161](#)
 - CD player [158](#)
 - radio [153](#)
 - Scan
 - CD changer [161](#)
 - CD player [158](#)
 - radio [152](#)
 - Scan sampling
 - CD changer [161](#)
 - CD player [158](#)
 - radio [153](#)
 - Screen, refer to Control Display [15](#)
 - Seat heating [49](#)
 - Seat memory [53](#)
 - Seats
 - adjusting the seats [44](#)
 - sitting safely [44](#)
 - "Seat temp." [50](#), [106](#)
 - Seat ventilation, refer to Active seat ventilation [50](#)
 - SECAM during TV mode [164](#)
 - Securing cargo, refer to Cargo [125](#)
 - Securing the load [118](#)
 - Selecting a new route for the navigation system [140](#)
 - Selecting distance with active cruise control [76](#)
 - Selecting new scale for navigation system display [140](#)
 - Selecting stored radio stations [154](#)
 - Selecting the waveband on the radio [152](#)
 - Selection options with navigation system [132](#)
 - Selector lever, automatic transmission [66](#)
 - "Service" [81](#), [198](#)
 - "Emissions inspection" [82](#)
 - "Spark plugs" [81](#)
 - "State inspection" [82](#)
 - Service and Warranty Information Booklet for US models [198](#)
 - Service brakes [123](#)
 - Service Interval Display [81](#), [198](#)
 - Service Requirement Display, refer to Service Interval Display [198](#)
 - "SET", refer to Setting the speed limit [86](#)
 - "Set time" [109](#)
 - Setting brightness of Control Center [89](#)
 - "Settings" [18](#), [21](#), [24](#)
 - Setting the brightness [89](#)
 - Setting the speed limit [86](#)
 - Setting time and date [88](#)
 - Shiftlock [67](#)
 - Short commands for voice command system [28](#)
 - Shortest distance [137](#)
 - "Shortest route" [137](#)
 - "Short info" [18](#)
 - Shoulder support [46](#)

Side marker lamps [99](#)
Side window blind, refer to
 Sun blinds [112](#)
Sitting safely [44](#)
 – with airbags [44](#)
 – with safety belts [44](#)
Ski bag [117](#)
Sliding/tilt sunroof, refer to
 Glass roof, electric [42](#)
Snow chains [193](#), [193](#)
Soft Close Automatic
 – doors [37](#)
 – luggage compartment
 lid [38](#)
SOS [177](#)
Sound system adjustments
 – midrange setting [151](#)
Spare fuses [206](#)
Spare key [32](#)
 – adapter [32](#)
Spare tire [203](#)
"Spark plugs" [81](#), [198](#)
Speed limit
 – "Limit" [86](#)
Speedometer [12](#)
"Speed Vol." for audio
 mode [150](#)
"Sport"
 – "EDC" [94](#)
Sport program with the
 automatic
 transmission [67](#)
Sports seat [45](#)
Stability control, refer to
 Driving stability control [92](#)
Standard during
 TV mode [164](#)
Standing lamps [100](#)
 – replacing bulbs [201](#)
Start/Stop button [60](#)
Starting [61](#)
Starting assistance [207](#)
Starting problems [61](#), [208](#)
Starting the destination
 guidance [139](#)
Starting the engine [61](#)
"State inspection" [82](#)
Station, refer to Radio [152](#)

"Stationary" [106](#), [109](#)
Status lines in Control
 Center [23](#)
Steering wheel [16](#)
 – adjustment [52](#)
 – adjustment, automatic [52](#)
 – heater [52](#)
 – individual button
 assignment options [52](#)
 – memory [53](#)
Steptronic [66](#)
Stopwatch [87](#)
Storage, refer to the Caring
 for your vehicle brochure
Storage
 compartments [114](#), [115](#)
Storing desired speeds,
 refer to Programmable
 cruise control [73](#)
Storing destination per
 voice [142](#)
Storing seating position,
 refer to Seat, mirror and
 steering wheel
 memory [53](#)
Straps, refer to
 Loading [125](#)
"SUBTITLE" for
 DVD mode [168](#)
Summer tires [192](#)
Sun blinds [112](#)
Supply reservoir, washer
 system [71](#)
Switch for battery [205](#)
Switching air conditioner
 mode on and off
 manually [104](#)
Switching off rear air
 conditioner [108](#)
Switching off the engine [61](#)
Switching off the portable
 phone [178](#)
Switching off the tilt alarm
 sensor [34](#), [40](#)

Switching on
 – audio [149](#)
 – CD changer [160](#)
 – CD player [158](#)
 – DVD changer [166](#)
 – portable phone [178](#)
 – radio [152](#)
 – TV [163](#)
Symbols [4](#)
 – Control Center [19](#)

T

Tachometer [80](#)
Tail lamps [202](#)
Target cursor for
 navigation [134](#), [135](#)
Technical data [212](#)
Technical modifications [6](#)
Telephone
 – operation with the
 telephone keypad,
 folding [176](#)
 – refer to Portable phone
Telephone keypad,
 folding [176](#)
Television, refer to TV [163](#)
Temperature
 adjustment [104](#)
Temperature display,
 outside temperature [80](#)
Temperature
 distribution [50](#)
Third brake lamp, refer to
 Brake lamps [202](#)
Tilt function, passenger-
 side mirror [54](#)
Time of arrival [85](#)
Timing [87](#)
"Tint" for TV mode [164](#)
Tire inflation pressure [188](#)
Tire pressure monitoring,
 refer to Flat Tire
 Monitor [95](#)
Tire Quality Grading [190](#)

- Tires
 - flat tire 203
 - tire changes 203
 - tire damage 191
 - tire inflation pressure 188
 - tire replacement 192
 - tire size, refer to Wheel and tire combinations 192
 - tire tread 191
 - tread wear indicators 191
 - "TITLE" 167
 - Tone, adjusting 149
 - "Tone" for audio mode 148, 150
 - Tools 200
 - "TOP 8" 180
 - "TOP" for DVD mode 169
 - Topping up washer fluid 71
 - Torque 212
 - Tow fittings 208, 209
 - Towing
 - with raised front axle 208
 - Track 213
 - Traction Control System, refer to DSC 92
 - Traffic congestion, refer to Selecting a new route 140
 - Transmission, refer to Automatic transmission with Steptronic 66
 - Transmission lockout, refer to Park detent 67
 - Transporting children safely 56
 - Travel route, refer to Route 140
 - Tread depth, tires 191
 - Treble 149
 - "Treble" for audio mode 150
 - Trip computer 86
 - Trip odometer 80
 - Trunk lid, refer to Luggage compartment lid 37
 - Turning circle 213
 - Turn signal indicators 69
 - replacing bulbs 201, 202
 - "TV" 163, 164
 - TV 163
 - adjusting the picture 164
 - adjusting the tone 149
 - controls 148
 - NTSC 164
 - PAL 164
 - programs 163
 - SECAM 164
 - selecting standard 164
 - switching on 163
 - volume 149
 - "TV format" 164
- ## U
- Undercoating, refer to Caring for your vehicle brochure
 - Uniform Tire Quality Grading 190
 - Universal garage door opener, refer to Integrated universal remote control 111
 - Unlatching the engine hood 194
 - Unlocking without key, refer to Comfort Access 34
 - Upholstery care, refer to the Caring for your vehicle brochure
 - Used batteries 206
- ## V
- Vacuum cleaner connection 116
 - Valve caps 204
 - Vanity mirror 51
 - Vehicle battery 205
 - Vehicle dimensions 213
 - Vehicle jack 203
 - Vehicle keys 32
 - Vehicle Memory 54
 - Ventilation 105
 - draft-free 105
 - while parked 109
 - Vents, refer to Ventilation 102
 - "Video" 148
 - "View" for navigation 139, 140
 - Viscosity 196
 - Voice command system 16, 25
 - Voice guidance for navigation 141
 - Volume
 - audio 149
 - CD changer 149
 - CD player 149
 - DVD changer 149
 - navigation 141
 - portable phone 177
 - radio 149
 - TV 149
 - voice command system 26
- ## W
- Warm feet, cool headroom, refer to Front ventilation 105
 - Warning lamps 12
 - Warning messages 82
 - Warning triangle 207
 - Warranty and Service Guide Booklet for Canadian models 198
 - "WB" 148, 155
 - Wear indicators in the tires 191
 - Weather Band 155
 - Weights 214
 - Wheel and tire combinations 192
 - Wheelbase 213
 - Wheel bolts
 - wrench 203
 - Wheels and tires 192
 - Width 213
 - "Window" 107
 - Windows 41
 - convenience operation 36
 - remote control 34
 - safety switch 42

Windshield wiper blade
replacement [200](#)
Windshield wiper
system [70, 71](#)
Winter tires [192](#)
– speed limit selection [86](#)
Wiper blade
replacement [200](#)
Wiper system [70](#)
"With highway" [137](#)
"With map" for
navigation [134, 135](#)
Wordmatch principle for
navigation [138](#)
Working in the engine
compartment [194](#)

X

Xenon lamps [201](#)

Refueling

To ensure that you always have all the essential data at hand when refueling, we recommend that you fill in the following tables with the specifications and information that apply to your vehicle. Consult the index for individual specifications.

Fuel

Designation

Please enter your preferred fuel here.

Engine oil

Quality

The oil quantity between the two marks on the dipstick is approx. 1.65 US quarts/ 1.5 liter.

Tire inflation pressures

	Summer tires Front	Rear	Winter tires Front	Rear
--	-----------------------	------	-----------------------	------

Up to 4 persons

5 persons or 4 plus luggage

More about BMW

bmwusa.com



The Ultimate
Driving Machine